

# Tooling solutions for advanced high strength steels

Technical brochure





# Contents

<b>Introduction</b>	<b>5</b>
About SSAB	6
<i>General</i>	6
<i>SSAB's advanced high strength steel and its benefits for the automotive industry</i>	6
<b>Sheet steels and tool steels</b>	<b>8</b>
Advanced High Strength Steels	8
<i>Micro alloyed steels</i>	8
<i>Bainitic steels</i>	8
<i>Dual phase steels</i>	8
<i>Complex Phase steels</i>	8
<i>Roll forming steels</i>	8
<i>Martensitic steels</i>	8
<i>Available dimension range</i>	8
Tool steels	10
<i>Characteristics for forming and cutting operations</i>	10
<i>Conventional metallurgy</i>	11
<i>Electro slag remelting metallurgy</i>	11
<i>Powder metallurgy</i>	11
<b>Tool steel selection guidelines</b>	<b>12</b>
Overview	12
Forming tool operations	14
<i>General</i>	14
<i>Bending</i>	14
<i>Roll forming</i>	14
<i>Stamping</i>	14
<i>Hole flanging</i>	14
<i>FEM analysis of tool loads and galling</i>	15
<i>Tool steel selection and surface treatment in forming applications</i>	16
Cutting tool operations	18
<i>General</i>	18
<i>Blanking and punching</i>	18
<i>Cutting and shearing</i>	24
<i>Tool steel selection and surface treatment in cutting applications</i>	26
Application examples	32
<i>B-pillar reinforcement</i>	32
<i>Bumper for passenger car</i>	33
<i>Tow hook bracket</i>	33
<b>Lubrication</b>	<b>34</b>
Forming tool operations	34
Cutting tool operations	34
<i>Docol HR LA grades, uncoated</i>	34
<i>Docol DP/DL/LA and Roll grades, uncoated</i>	34
<i>Docol DP/CP/LA and Roll grades, hot-dip galvanized</i>	34
<i>Docol M grades, uncoated and electro galvanized</i>	34
<b>Tooling economy</b>	<b>35</b>
<b>Technical support</b>	<b>37</b>
Experts to help you	37
Advanced resources for analysis	37
Courses and seminars	38
Handbooks	38
Trial sheets	38
Product information	38



# Introduction

Using advanced high strength steels (AHSS) can provide organizations with many advantages. However, with the increasing use of advanced high strength steel in new product designs, higher demands are also placed on tool steels used in forming and blanking/punching operations. The purpose of this publication is to provide selection guidelines that enable design engineers and material experts to find the best tooling solution for forming and blanking/punching advanced high strength steels with the following steel types:

- Micro alloyed steels
- Bainitic steels
- Dual phase steels
- Complex Phase steels
- Roll forming steels
- Martensitic steels

From an environmental standpoint, advanced high strength steels can significantly reduce weight in producing a detail, allow for smaller amounts of raw material to be used and consume less energy. At the same time, less energy is needed to transport the steel and the steel itself is also totally renewable.

There are also applications where advanced high strength steel makes it possible to exclude tempering furnaces from the manufacturing process, and consequently the environmental hazards involved.

In the automotive industry, lower emission levels can be achieved by reducing vehicle weight. On the other hand, the ever increasing demand for safety in cars necessitates higher strength materials to be used in critical safety elements in the car body. There are also many industrial products where reduced weight and increase product durability can be achieved by utilizing advanced high strength steel in their designs.

The use of advanced high strength steel may require higher force to cut and form the sheet steel. Therefore, the need for higher hardness and ductility in the tool steel becomes obvious. The present situation and future development in advanced high strength steel forces the desired tool steel properties to develop even further to match the requirements.

The guidelines presented here reflect the latest results and best working practices at the time of release of this publication. The information is based on comprehensive research and testing performed over a long period, and in close cooperation with many of our most advanced customers.

The main goal for SSAB is to provide solid information to enable customers to select the best combination of advanced high strength steel and tool steel for any given product design.

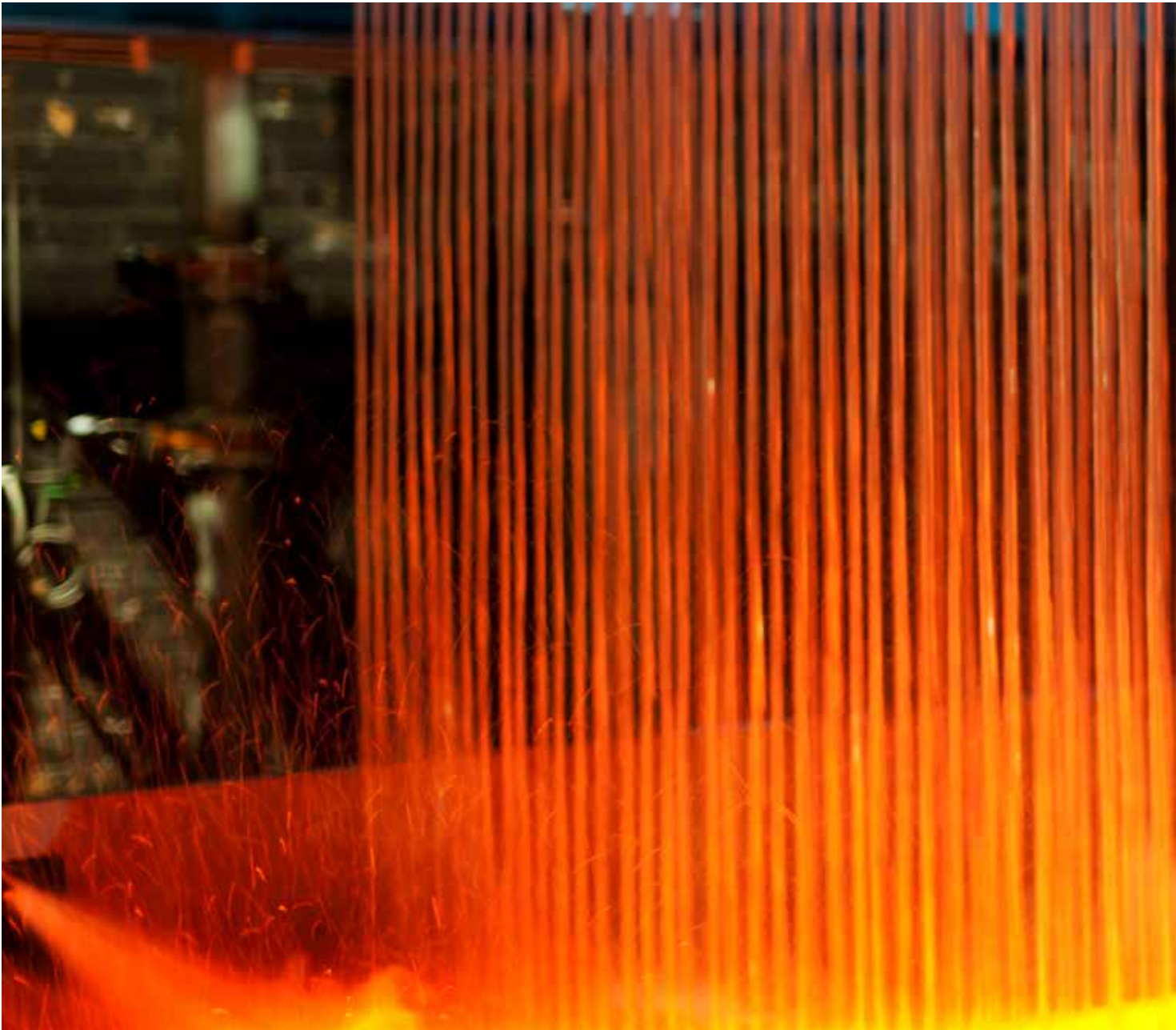

## About SSAB

### General

SSAB is a global leader in value added, high strength steel and offers products developed in close cooperation with its customers to reach a stronger, lighter and more sustainable world. Production facilities are located in North Europe and the USA and local supply is available in 50 countries around the world.

SSAB's product brands Strenx, Hardox, Docol, GreenCoat, Armox and Toolox are well known and internationally recognized for their quality and value added services. With a strong customer focus we offer support in developing the most innovative products on the market, right from the start of an application's development. We are open-minded, straightforward, honest, and by sharing our vast experience and knowledge, provide you with values that are difficult to find in today's business environment. Our customers include well known OEM's and can be found in a broad cross section of demanding industries, including automotive, trailer, tipper, crane, lifting, container and agricultural machinery.

### **SSAB's advanced high strength steel and its benefits for the automotive industry**

Cars are becoming ever better in terms of safety, comfort and fuel consumption. This trend is driven by increased safety and environmental demands. The utilization of SSABs advanced high strength steels results in lightweight constructions, improved safety and cost-efficiency.

SSAB supports its automotive customers right from the beginning of the product development process for specific applications, enhancing their competitive advantage and profitability. For example, weight savings of up to 50% are attainable by switching from mild steel to one of SSABs strongest steels for safety components.

The development and improvement of advanced high strength steels for new applications, plus the creation of new methods for design, forming and joining the material is central to SSABs



research and development program. We have invested heavily in advanced production processes to guarantee high quality. All steel production has virtually the same properties to ensure that dimensions, tolerances and internal properties of the steel are consistent. This level of quality not only reduces rejection rates, but also ensures continuity of production to customers. Our product range includes thin sheet steel with a thickness range from 0.4 mm to 16 mm, plus a maximum sheet width of 1,600 mm.



# Sheet steels and tool steels

## Advanced high strength steels

Advanced high strength steels available from SSAB can be obtained as hot rolled, cold reduced, hot-dip galvanized and electro galvanized products. For example, Advanced High Strength Steels are used in:

- Safety components in cars
- Trailers
- Tippers
- Seat components
- Containers
- Cranes
- Trains
- Various tube applications such as furniture, bicycles and baby carriages

There are several parameters that decide which of the Advanced High Strength Steel types to be used. The most important parameters are derived from the geometrical form of the component and the selection of forming and blanking method. Some of the advanced high strength steels available from SSAB are shown in **Table 1**.

More information about the use and processing of these steel types can be found in product brochures from SSAB or on web-page: [www.ssab.com](http://www.ssab.com)

### Micro alloyed steels

The micro alloyed cold-forming steels derive their high strength from the addition of very small quantities of micro-alloying elements such as niobium and titanium. These steel grades are designated according to the lowest guaranteed yield strength. The difference between their yield strength and tensile strength is small. These steel grades have excellent bendability, press-forming and flanging properties in relation to their yield strength. The weldability is also good.

### Ferritic-bainitic steels

The ferritic-bainitic steels are available as hot rolled material. These types of steels are thermo-mechanical rolled. The figures in the steel designation specify the minimum tensile strength.

### Dual phase steels

Dual Phase, cold-forming steel has a microstructure that consists of two phases, ferrite and martensite. Ferrite is soft and contributes to good formability. Martensite is hard and contributes to

the strength of the material. The strength increases with increasing proportion of the hard martensite phase. Depending on the application, dual phase steels in different yield ratio (YS/TS) can be achieved. The figures in the steel designation specify the minimum tensile strength. Dual phase steels are easy to cut and form and can be welded with conventional welding methods.

### Complex Phase steels

The microstructure of complex phase steels contains small amounts of martensite, retained austenite and perlite within the ferrite/bainite matrix. CP steels are characterized by a high yield strength, moderate strain hardening and good ability for bending and flanging. The figures in the steel designation specify the minimum tensile strength. The complex phase steels are available as hot-dip galvanized steel grades.

### Roll forming steels

The roll forming steels are available as cold reduced and hot-dip galvanized products. This group of steel is primarily designed for applications where roll forming is used as a forming method. The roll forming steels are characterized by high yield ratio (YS/TS), high internal cleanliness and a microstructure with homogeneous hardness distribution. These characteristics minimize the risk for twisting and bending of the profile, and make it possible to roll form into narrow radii.

### Martensitic steels

Martensitic steels contain 100% martensite. Martensitic steels characterize a material in very high yield and tensile strength. For hot rolled material, the figures in the steel designation specify the minimum tensile strength, and for cold rolled material, the minimum tensile strength.

### Available dimension range

Thickness:	Docol	0,50–2,10 mm
	Docol-GI	0,50–3,00 mm
	Docol HR	2,00–12,00 mm
Max width:	Docol	1500 mm
	Docol-GI	1500 mm
	Docol HR	1600 mm

Limitation in max width is depending on steel grade and thickness of the material. Additional thicknesses available at request.





Type of steel	Steel grade	CR/HR	UC	EG	GI	GA	ZA	
High Strength Low Alloy Steels	Docol 460LA	CR	x	x	x	x	x	
	Docol 500LA	CR	x	x				
	Docol 800LA	CR	x	x				
	Docol HR460LA	HR	x	x				
	Docol HR500LA	HR	x	x				
	Docol HR550LA	HR	x	x	x			
	Docol HR600LA	HR	x	x				
	Docol HR650LA	HR	x	x				
	Docol HR700LA	HR	x	x	x			
Dual Phase steels	Docol 500DP	CR	x	x				
	Docol 500DL	CR	x	x				
	Docol 590DP	CR	x	x	x	x	x	
	Docol 600DP	CR	x	x				
	Docol 600DL	CR	x	x				
	Docol 780DP	CR	x	x	x	x	x	
	Docol 800DP	CR	x	x				
	Docol 800DL	CR	x	x				
	Docol 800DPX	CR				x	x	x
	Docol 980DP	CR	x	x	x	x	x	x
	Docol 1000 DP	CR	x	x				
	Docol 1000DPX	CR				x	x	x
	Docol 1000LCE	CR	x	x	x			
Complex Phase and Ferritic-Bainitic steels	Docol 600CP	CR			x	x	x	
	Docol 980CP	CR	x	x	x	x	x	
	Docol 1180CP	CR	x	x	x			
	Docol Roll 800	CR	x	x				
	Docol Roll 1000	CR	x	x				
	Docol HR600FB	HR	x	x	x			
	Docol HR800CP	HR	x	x	x			
	Docol HR800HER-75	HR	x	x				
	Docol HR800HER-100	HR	x	x				
	Docol HR1000CP	HR	x	x				
Martensitic steels	Docol 900M	CR	x	x				
	Docol 1100M	CR	x	x				
	Docol 1200M	CR	x	x				
	Docol 1300M	CR	x	x				
	Docol 1400M	CR	x	x				
	Docol 1500M	CR	x	x				
	Docol 1700M	CR	x	x				
	Docol HRI200M	HR	x					
	Docol HR 1500 M	HR	x					

Table 1. This table shows only some few examples of our high-strength steels. In addition grades produced to Automotive DEM standards are widely available. SSAB also offer mild steels and lower grades of HSS.

## Tool steels

### Characteristics for forming and cutting operations

A typical request for tools used in cold work applications is a high hardness. The reason is that the work materials to be formed are often hard. A high tool hardness is therefore necessary to prevent plastic deformation and/or heavy tool wear.

A negative consequence of high hardness level is that the tool material becomes more brittle.

Tool steel for cold work applications need high wear resistance, sufficient compressible strength and toughness/ductility or, more specifically:

- High wear resistance to increase tool life and to reduce the need for production stoppages for tool maintenance.
- Sufficient compressible strength to avoid plastic deformation of the active tool surfaces.
- Sufficient toughness/ductility to avoid premature tool breakage and chipping.

High wear resistance is not just a question of hardness. Typically, tool steel grades for cold work applications also contain hard carbides, giving an extra contribution to the wear resistance. These carbides are chemical compounds of carbon and carbide forming elements such as chromium, vanadium, molybdenum or tungsten. Generally, the more frequent, larger and harder the carbides are, the better wear resistance is achieved in the tool. There are, however, conflicting consequences as high hardness

makes the material sensitive to notches. This may lead to large carbides acting as crack initiators in a fatigue process. The majority of broken tools fail due to fatigue cracking.

Fatigue cracking occurs when the material is exposed to alternating/pulsating loads and can be divided in a crack initiation stage and a crack propagation stage. Crack initiation normally takes place at notches, which magnify the stress locally by stress concentration. The higher the hardness the more efficient the stress concentration becomes. Typical for a high hardness is also that as soon as a crack is initiated, the time to a total tool breakage is very short.

The difficulty with cold work applications in general, especially when blanking hard work materials, is that you must minimize crack initiating defects. This must be done while maintaining wear resistance which demands high hardness and hard particles in the steel matrix.

Crack initiating defects such as notches are not necessarily due to carbides. Large slag inclusions, defects in the tool surface or sharp corners in combination with high hardness may also act as sites for crack initiation at fatigue loading. For this reason, the cleanliness of the metallurgical process and the surface finish of the tool or the tool design will strongly influence tool performance. In **Table 2** the Uddeholm product range of tool steel suitable for advanced high strength steel is shown.

Steel grade Uddeholm	Type of metallurgy	AISI/W.-Nr.	Chemical composition (weight %)						
			% C	% Si	% Mn	% Cr	% Mo	% W	% V
Sleipner	Conventional	-	0,90	0,90	0,50	7,80	2,50	-	0,50
Sverker 21	Conventional	D2/1.2379	1,55	0,30	0,40	11,30	0,80	-	0,80
Calmax	Conventional	-/1.2358	0,60	0,35	0,80	4,50	0,50	-	0,20
Unimax	Electro slag remelting	-	0,50	0,20	0,50	5,00	2,30	-	0,50
Caldie		-	0,70	0,20	0,50	5,00	2,30	-	0,50
Vanadis 4 Extra SuperClean	Powder metallurgy	-	1,40	0,40	0,40	4,70	3,50	-	3,70
Vanadis 8 SuperClean	Powder metallurgy	-	2,30	0,40	0,40	4,80	3,60	-	8,00
Vancron SuperClean	Powder metallurgy	-	3,00 <sup>1)</sup>	0,50	0,40	4,50	3,20	3,70	8,50

1) %(C+N)

Table 2. Uddeholm product range of tool steels suitable for advanced high strength steel.

### Conventional metallurgy

When manufacturing conventional high alloyed tool steels, the use of large ingots means that the steel melt will solidify slowly. This results in coarse carbide networks being developed. These carbide networks will cause coarse carbide streaks in the tool material after rolling or forging. These carbide streaks are positive for the wear resistance but have a negative influence on the mechanical strength of the tool material, especially at fatigue loading.

To reduce the negative influence of carbide networks the chemical composition has to be balanced to reduce or even avoid coarse carbide networks, while compensating for the loss of wear resistance by the increased matrix hardness.

An alternative way is to develop a metallurgical process which gives small and well distributed carbides that have less negative impact on fatigue strength but still protect the tool from wear.

Uddeholm has two metallurgical processes to improve the situation compared to conventional metallurgy. These are:

- Electro slag remelting (ESR)
- Powder metallurgy (PM)

The metallurgical processes are described below.

### Electro slag remelting metallurgy

Electro slag remelting is a well-known metallurgy process in which a conventionally produced ingot is successively remelted in a process with a small steel melt. This smaller steel melt solidifies much faster than a larger steel melt, giving less time for carbide growth after solidifying. The remelting process gives steel with improved homogeneity and less overall carbide sizes. The process also includes a slag filter, which improves the steel cleanliness.

### Powder metallurgy

In the powder metallurgy process nitrogen gas is used to atomize the melted steel into small droplets, or grains. Each of these small grains solidifies quickly and there is little time for carbides to grow. These powder grains are then compacted to an ingot in a hot isostatic press at high temperature and pressure. The ingot is then rolled or forged to steel bars by conventional methods. The resulting structure is completely homogeneous steel with evenly distributed small carbides, harmless as sites for crack initiation but still protecting the tool from wear.

Large slag inclusions can take the role as sites for crack initiation instead. Therefore, the powder metallurgical process has been further developed in stages to improve the cleanliness of the steel. Powder steel from Uddeholm today is of the third generation. It is considered the cleanest powder metallurgy tool steel product on the market.

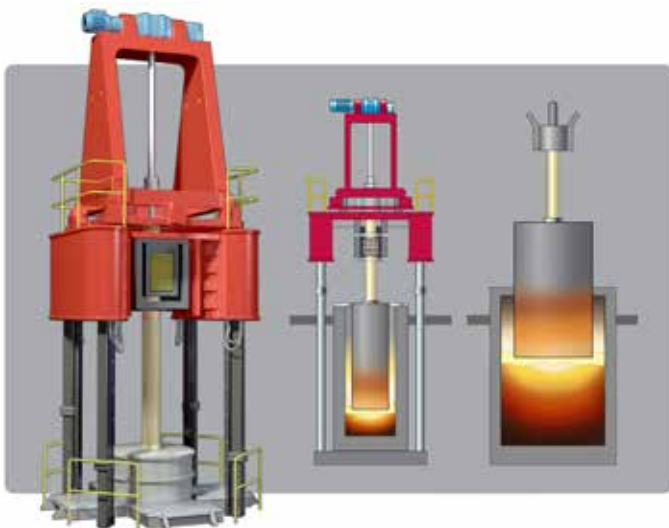

Figure 1. Electro slag remelting metallurgy.

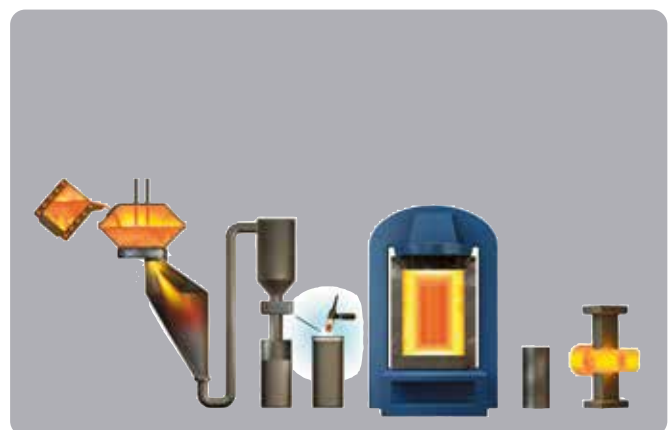
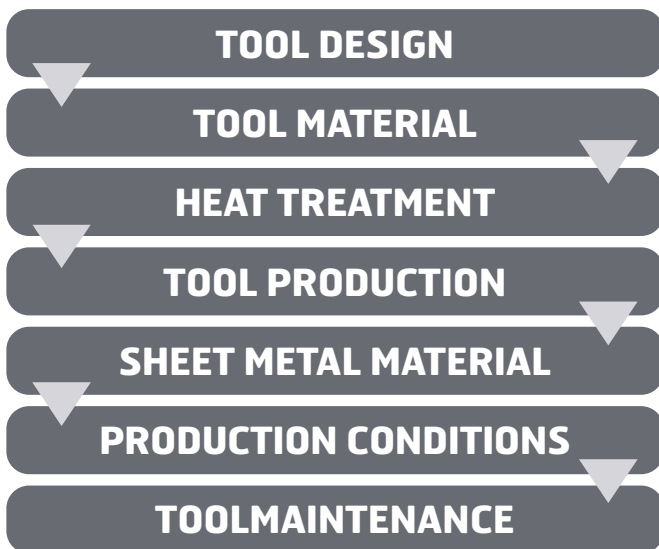

Figure 2. Powder metallurgy.

# Tool steel selection guidelines

## Overview

In forming and cutting operations of sheet metal parts, as in all industrial manufacturing operations, it is important that the production runs are trouble free. The chain from tool design to tool maintenance includes many different steps as shown in **Figure 3**.



*Figure 3.*  
*Process steps from tool design to tool maintenance.*

To achieve good productivity and tooling economy it is essential that the right tool steel is selected and that all steps in the chain are carried out correctly.

To select the right tool steel for the application in question it is essential to identify the mechanisms which can lead to premature tool failures. In forming and cutting operations there are five principal failure mechanisms:

- Plastic deformation, which appears when the operating stress level exceeds the compressive yield strength (hardness) of the tool steel.
- Abrasive wear, related to the operation, the work material and the friction forces due to sliding contact between the tool and the work material.
- Chipping, which is a result of high working stresses compared to the fatigue strength of the tool steel.
- Adhesive wear/Galling (pick-up), which is a result of heavy friction forces due to the sliding contact and the adhesive nature of the work material. The galling mechanism is closely related to adhesive wear.
- Total cracking, which is a result of high working stresses compared to the fracture toughness of the tool steel.



Plastic deformation, chipping and total cracking are spontaneous failures and result in severe and costly production disturbances. They must be avoided if possible. Wear and galling are more predictable and can, to a certain extent, be handled by tool maintenance schedules. A consequence of this is that it may be worthwhile to allow more tool wear rather than to run into situations with chipping and cracking.

The yield strength of the steel sheet has to be exceeded during forming and the shear rupture strength has to be exceeded during cutting. This means that in forming and cutting operations in advanced high strength steel sheets, the forces needed to perform the operation are higher than for softer sheets of the same thickness.

In the same way, the demands on wear resistance and mechanical strength of the tool material increase. The cutting operation is more sensitive since it requires a combination of high wear resistance, high galling resistance, high compression strength, high chipping and total cracking resistance. On the other hand, the forming operation is more concerned with high wear and galling resistance and compression strength.

Furthermore, the die clearance has to be changed. Shock waves may appear and the burr formation is different when blanking/punching sheets with  $R_m$  1,200–1,400 MPa. See also **Figure 3**. Forming of advanced high strength steels also means a reduced formability, increased spring back and increased wrinkling tendencies. The tooling environment becomes accordingly more complex and demanding with these new advanced high strength steel materials.

Forming and cutting operations in sheets of higher strength steel grades may lead to rapid deterioration of the tool surface, or cracking of the tool if inadequate tool steels are selected. This means the selection of tool steel and coating processes for forming and cutting operations in advanced high strength steel should not be based on what was done in the past with softer mild steel sheet materials. Instead, one should use the latest technical innovations to optimize the production economy.

In **Table 3** a relative comparison of the resistance to different types of tool failure mechanisms for the Uddeholm product range intended for advanced high strength steel applications is shown.

Steel grade Uddeholm	AISI	Hardness/ Resistance to plastic deformation	Wear resistance		Resistance to fatigue crack initiation	
			Abrasive wear	Adhesive wear	Ductility/Resistance to chipping	Toughness/ Resistance to cross cracking
Calmax	-	██████████	████	██████████	██████████	██████████
Caldie	-	██████████	████	██████████	██████████	██████████
Sleipner	-	██████████	██████	██████████	████	██████████
Sverker 21	D2	██████████	██████	████	████	██████████
Unimax	-	██████████	████	██████████	██████████	██████████
Vanadis 4 Extra*	-	██████████	██████	██████████	██████████	██████████
Vanadis 8*	-	██████████	██████	██████████	██████	██████
Vancron*	-	██████████	██████	██████████	██████	██████

Table 3. Relative comparison of the resistance to different types of tool damage in cold work applications for recommended tool steels for advanced high strength steels.

\*Uddeholm PM SuperClean tool steel.

## Forming tool operations

### General

Advanced high strength steels from SSAB have good formability and can be formed in the traditional way, despite their high strength. The somewhat lower formability compared to mild steels can almost always be compensated by modifying the design of the component or the forming process. Larger radii in the tool that help the material flow in combination with optimized blank shape are factors that can make the forming of advanced high strength steels easier. A good example when these design issues have been taken into account is shown in **Figure 4**, able to stamp a quite complex part in Docol 1200M even though in general term the formability of advanced high strength steel is lower compared to mild steel, see **Figure 5**.



Figure 4. A battery holder for a SUV car, stamped in Docol 1200M.



Figure 5. Maximum cup height and dome height for deep drawing and stretch forming, respectively. Steel grades (from left to right): CR5, Docol 600DP, Docol 800DP, Docol 1000DP, Docol 1200M and Docol 1400M.

The spring back effect is larger for high strength steel than for milder materials. Several methods to reduce spring back are possible, for example:

- Over-bending
- Increasing blank holder force
- Using calibration step
- Using draw beads
- Adding stiffeners to flat areas and bends of the part
- Using the correct blank shape

In the following of **section Forming tool operations**, forming operations such as bending, roll forming, stamping and hole flanging, as well as some aspects regarding tool loads and galling using the Finite Element Method (FEM), are discussed. Recommendations for surface treatment and tool steel selection are also given.

### Bending

When bending a soft material, the resulting inner radius is determined mainly by the die width and not by the bending knife radius. A high strength material, on the contrary, follows the bending knife radius and the resulting inner radius is less dependent on the die width. Therefore, a larger die width can be used with high strength steels without compromising the required inner radius. This has a large influence on the bending force and also on the tool wear, which are both reduced when the die width is increased.

When transferring from softer to high strength sheet steel, the sheet thickness is generally reduced. The bending force may therefore remain unchanged, since the reduced thickness often compensates for the higher strength.

### Roll forming

Roll forming is extremely suited for advanced high strength steel. Experiments show that significantly sharper radii can be obtained using roll forming compared to conventional bending.

### Stamping

Press forces increase with increasing work material strength. Generally, a high strength material also requires higher blank holder force to prevent wrinkling. High surface pressure locally in the tool puts high demands on the tooling material and on the tool surface properties (refer also to **section Overview**).

### Hole flanging

The hole flanging ability for high strength sheet steel is poorer than for softer materials. Because of this, it is more important to optimize the process as far as possible, for example by blanking the hole in opposite direction to the flanging direction. The burr is then located on the inside of the hole where it is least subjected to tension. Pre-forming before hole punching is another method to achieve higher flanging heights.



Figure 6. Complex stamping tool.

### FEM analysis of tool loads and galling

Numerical simulation using the Finite Element Method (FEM) can give valuable assistance in the selection of tool steel. One important question in tool steel selection is whether a sheet metal forming application can be performed without the occurrence of galling, which is often the dominating damage mechanism in sheet forming. The main reason for galling is too high contact pressure between the die and the sheet. The FE method can be used to calculate the contact pressure for a given combination of tool and sheet material. An example of a FEM simulation is shown in **Figure 7a** and illustrates the methodology of calculating contact pressure. From this calculation we get an idea about the level of tool pressure our tool steel must endure, and can base our tool steel selection on this result.

Choosing the right tool steel and surface treatment can increase the pressure limit for galling, allowing the forming of higher strength sheet material and/or more demanding geometries. The high nitrogen alloyed PM tool steel Uddeholm Vancron SuperClean has a higher resistance to galling than conventional tool steel. The contact pressure limit when forming Docol HR700LA and Docol 1000DP is approximately 1600 MPa when using Vancron SuperClean material in the tool. As a rule of thumb, it can be assumed that the limiting pressure for galling is about 2.6 times the yield strength when using Vancron SuperClean as tool steel material, but only 1.2 times the yield strength when using conventional tool steel materials such as AISI D2. This is valid for forming of sheet with strength up to Docol 1000DP, since above this strength, the temperature will increase and the lubricating film may no longer be able to carry the pressure. With the present knowledge the limits for recommended use of Uddeholm Vancron SuperClean can be stated as shown in **Figure 7b**.

Other important factors which will influence the galling limit are; choice of lubrication, surface roughness of the tool and sliding speed. One reason for the effect of the factors mentioned here is that they all influence temperature, which should be kept as low as possible to avoid galling.

The pressure limit can be combined with a FEM simulation to predict whether an application (with a given geometry) will produce low enough contact pressure to be successful with a conventional tool steel, or if you have to use a more advanced tool steel like Vancron SuperClean. However, a simulation that predicts low enough pressure is not a guarantee for success if the die surface preparation is poor. On the other hand, if the predicted contact pressure is just above the limit, improved lubrication, further reduction of the surface roughness or reduced forming speed can be sufficient to prevent galling.

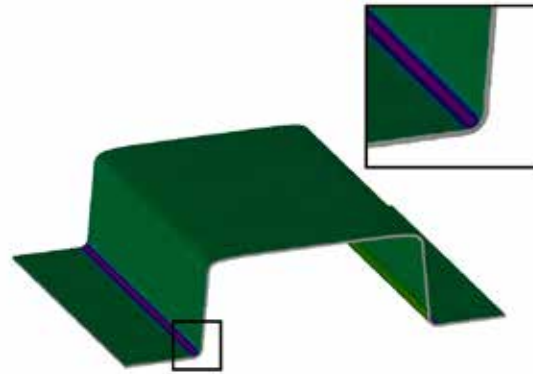

Figure 7a. Overview of computed contact pressure of a deep drawing operation of a hat profile in Docol 1000DP 1,5mm.

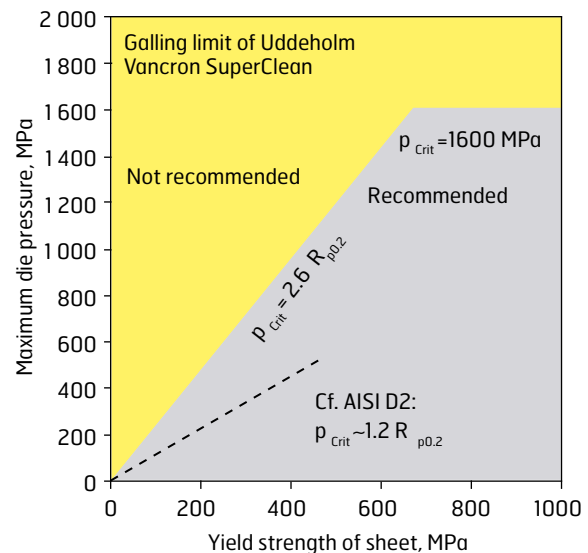

Figure 7b. Limits to guide the use of uncoated Uddeholm Vancron SuperClean to form carbon steel. Recommendations are based on application tests and FEM simulation. For comparison the approximate level of the galling limit of uncoated AISI D2 tool steel is included.

### Tool steel selection and surface treatment in forming applications

In forming applications, galling, adhesive wear and plastic deformation are the most common failure mechanisms encountered. Forming of advanced high strength steel sheet (or thicker high strength sheet) means that higher press forces are needed due to the higher yield strength.

Forming tools with better galling resistance will be needed in the future as the trend is towards an increased use of higher strength sheet materials, higher press speeds, the use of progressive dies with fewer steps and the use of more environmentally friendly (but normally less effective) lubricants. Surface treatment such as PVD, CVD and TD coating on the forming tool is an effective way to prevent galling.

Selection of the tool steel and the coating process used for forming advanced high strength sheet steels depend mainly on:

- The strength of the sheet steel
- The thickness of the sheet steel
- Whether the sheet steel is coated or not
- The complexity of the forming operation
- The number of parts to be produced

At present, there is only limited experience with forming of advanced high strength steels. However, some preliminary tests with 2 mm Docol 600DP–1000DP have indicated the following:

#### • Tool hardness levels

Tool hardness should be more than 58–59 HRC to counteract wear, galling and plastic deformation.

#### • Tool surface finish

Active tool surfaces should be polished to a low surface roughness ( $R_a \leq 0.2 \mu\text{m}$ ).

#### • Conventional uncoated tool steels

These steels do not fulfill the requirements for press tools for uncoated sheet material. However, they might be suitable for simpler forming operations with thinner advanced high strength sheet material at the lower end of the strength range.

#### • Plasma nitrided conventional tool steels

Such tool steels do not show sufficient galling resistance for long production runs due to delaminating of the nitride layer. However, they might be suitable for simpler forming operations with thinner advanced high strength sheet material at the lower end of the strength range.

#### • PVD coated tools

PVD coatings (e.g. CrN or TiAlN) in combination with a substrate steel having sufficiently high hardness (> 58 HRC) is one solution to avoid galling.

#### • CVD or TD coated tools

Properly prepared CVD or TD coated tools also avoid galling.



#### • Vancron SuperClean forming tools

Uddeholm Vancron SuperClean, which is nitrogen alloyed, high performance PM steel, has shown very good industrial application test results. Forming tooling (with a surface finish of  $R_a \leq 0.2 \mu\text{m}$ ) made from Uddeholm Vancron 40 SuperClean usually performs much better than coated tooling.

A summary of suitable tool steels for forming of advanced high strength steels is given in **Table 4a**. Table data is based on experience to date but testing will be continued and table data will be regularly updated. The mentioned tool steel grades can be used as mono block dies or in combinations of base die material with inserts, depending on the size of the tool and the severity of the forming operation.

As stated earlier there is a need for surface treatment or surface coating to achieve proper performance of the tools. This means that the coatings are taking care of the wear (except for Uddeholm Vancron SuperClean). The tool steel acts as a substrate for the coatings. The main demand on the substrate material is to support the very brittle coating, i.e. the substrate material must have enough compressive strength and hardness when the tool is put into service. Furthermore, the dimensional changes after the coating process must be negligible, or predictable to fulfill desired tolerances of the tool. Finally, the substrate material has to withstand many cyclic loads at high stress levels, i.e. a high fatigue limit is needed.

To give some guidance for tool steel selection at different demands on serial length, a relative ranking of actual tool steel grades without and with coating is given in **Table 4b**. In case of ion nitriding, one of the factors is that the ductility is heavily deteriorated. A comparison of the ductility after nitriding to a case depth of  $50 \mu\text{m}$  is made for the actual grades. As Uddeholm Vancron SuperClean is used without any surface treatments it shows a very much superior rating than all other grades.



Sheet strength R <sub>m</sub> (MPa)	Steel grade Uddeholm/AISI/W.-Nr.	Surface treatment/coating		Total hardness (HRC)
		Type	Serial length	
350-570	Calmax/-/1.2358 Unimax Sverker 21/D2/1.2379 Caldie Sleipner Vanadis 4 Extra SuperClean Vanadis 8 SuperClean Vancron SuperClean	Nitriding/PVD PVD/CVD PVD/CVD PVD/CVD PVD/CVD PVD/CVD PVD/CVD PVD/CVD No coating needed but can be applied	Medium runs Medium runs Medium runs Medium-long runs Medium-long runs Long runs Long runs All	> 58
>570-800	Calmax/-/1.2358 Unimax Sverker 21/D2/1.2379 Caldie Sleipner Vanadis 4 Extra SuperClean Vanadis 8 SuperClean Vancron SuperClean	Duplex (Plasma nitriding+PVD) PVD/CVD PVD/CVD PVD/CVD PVD/CVD PVD/CVD PVD/CVD No coating needed but can be applied	All All All All All All All All	> 60
>800-1400	Caldie Sleipner Vanadis 4 Extra SuperClean Vanadis 8 SuperClean Vancron SuperClean	PVD/CVD/Duplex PVD/CVD/Duplex PVD/CVD/Duplex PVD/CVD/Duplex No coating needed but can be applied	All All All All All	> 60

Table 4a Suitable tool steels for forming of advanced high strength steels.

Uddeholm	Without coating					With coating		With plasma nitriding
	Wear resistance			Resistance to:		Substrate material properties		
	Abrasive	Adhesive	Galling	Chipping/cracking	Plastic deformation	Fatigue limit	Dim. stability after rehardening	Ductility after nitriding to 50 µm depth
Calmax	1	3	1	8	1	4	4	6
Unimax	1	4	1	10	1	5	7	7
Caldie	2	5	2	8	5	9	7	5
Sleipner	5	4	2	3	8	2	4	3
Sverker 21	6	2	1	1	5	1	1	1
Vanadis 4 Extra SuperClean*	8	8	3	8	10	10	9	5
Vanadis 8 SuperClean*	10	8	5	6	10	9	9	4
Vancron SuperClean*	6	10	10	6	9	9**	10**	10**

\*) Uddeholm Vancron SuperClean without any surface treatment

\*\*\*) Without any surface treatment

Table 4b. The table shows a relative performance ranking for these grades, both without and with surface coating. Relative scale = 1-10, where 10 is best.

## Cutting tool operations

### General

It is very difficult to give conclusive advice regarding tool steel selection for a specific production situation because production conditions in different plants will never be the same, even if the same part is being produced at each plant. The best way is to base the selection of the tool steel on the experience gained from earlier production runs using the same or similar production equipment.

Regarding advanced high strength steel, there is little previous experience to date to go on. As mentioned earlier, it is important not to base the tool steel selection on what was done for softer production materials using older grades such as AISI A2 or D2.

Remember that there is a new generation of tool steels which are much more suitable for tooling when blanking and punching the advanced high strength steels.

In blanking and punching the main failure mechanisms usually are wear, chipping and galling. These failure mechanisms are influenced by:

- The strength of the production material
- The thickness of the production material
- The design features such as sharp radii
- The geometry of the part to be produced
- The number of parts to be produced

The tool must have sufficient hardness to prevent plastic deformation of the cutting edge. In addition, special attention must be given to the surface quality of the tool to prevent premature failure by chipping or cracking and also to prevent galling.

In the following of **section Cutting tool operations**, cutting operations such as blanking, punching, cutting and shearing are discussed. Recommendations for surface treatment and tool steel selection are also given.

### Blanking and punching

#### *Appearance of a cut edge*

Commonly used blanking and punching methods generate a cut edge consisting of a rollover, a burnish, a fracture zone and a burr. The burnish is smaller for high strength steel than for mild steel. The burr height is reduced with increasing tensile strength.

An important factor to achieve a good edge is the die clearance. How to select the die clearance is explained in **section Die clearance**.

### *Die clearance*

The die clearance is the radial distance between the punch and the die, see **Figure 9**.

The edge is often characterized by the four sections illustrated in **Figure 8**. Compared to blanking/punching in mild steel, the choice of die clearance has a greater influence on the tool life. However, the burr formation is smaller and not significantly affected by changing the die clearance. The rollover and fracture zone will increase with increasing die clearance, but less than for mild steel. In **Figure 10** the recommended die clearance for blanking and punching is shown.

In **Figure 11**, an edge can be seen after punching in Docol 1400M with 6 % and 14 % die clearance.

In general, it is better to use a larger die clearance when blanking/punching high strength sheet steel. However, for the highest strength sheet steels a very large die clearance can be a disadvantage. This will be explained later.

When blanking/punching steels up to 1,000 MPa tensile strength, a small die clearance gives a high amount of galling on the tool. A too large clearance gives less tool wear, but generates more bending or rollover in the work object resulting in lower edge quality. This is why the desired edge quality of the work object affects the choice of die clearance. The relation between tool wear and die clearance is shown in **Figure 12**.

When blanking/punching in the highest strength material, too small a die clearance also gives some galling on the tool, but the main wear mechanism is abrasive wear. Because of the material strength, there is a limit on how large the die clearance can be. Too large a die clearance generates high bending stresses on the punch edge, which increases the risk of chipping, see **Figure 13**. This is especially important in sheet materials with a small difference between yield and tensile strength as in the martensitic Docol M grades.

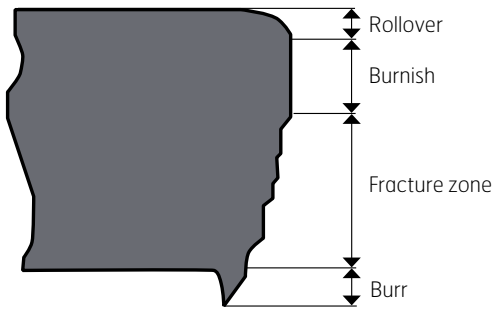

Figure 8. Appearance of a cut edge.

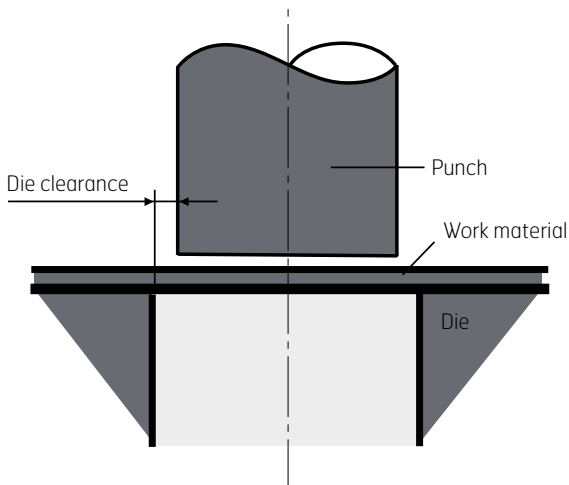

Figure 9. Die clearance definition.

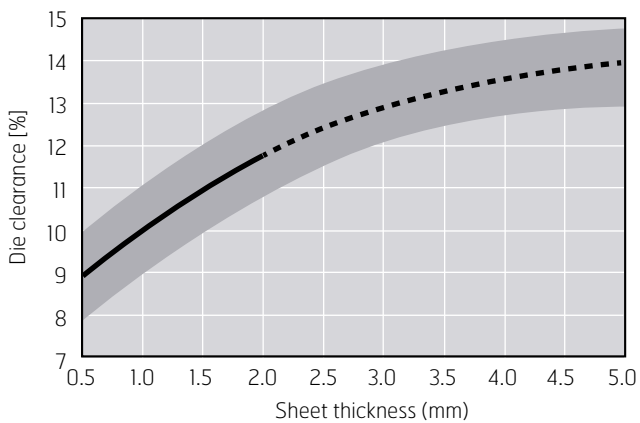

Figure 10. Recommended die clearance for blanking/punching advanced high strength steel.

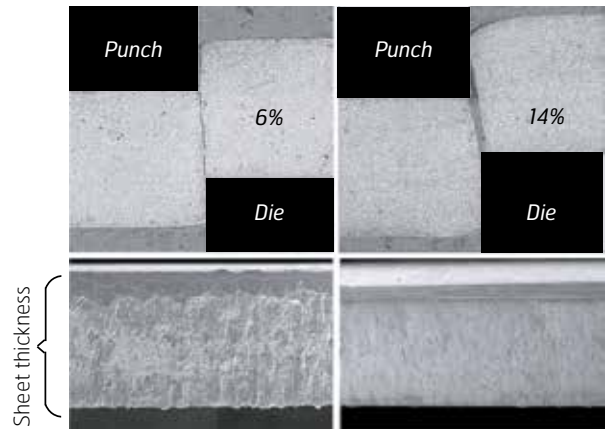

Figure 11. Edge cut with varying die clearance.

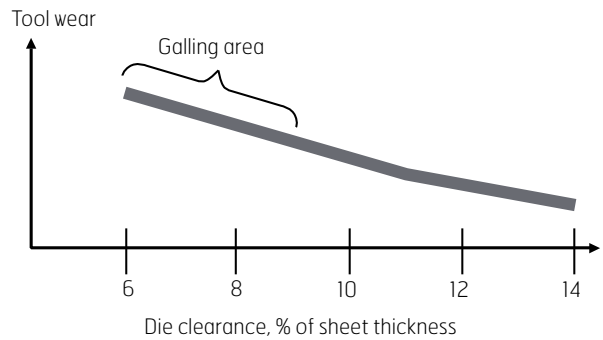

Figure 12. Relation between tool wear and die clearance when blanking in Docol 800DP (sheet thickness = 1 mm).

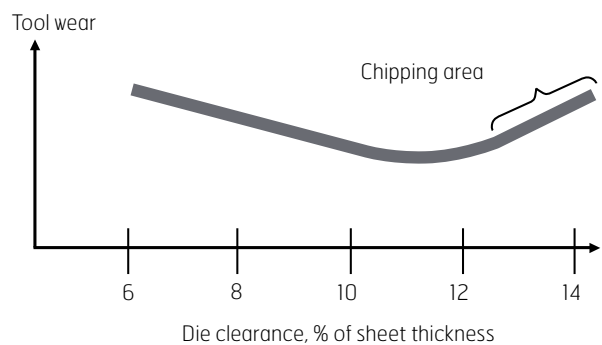
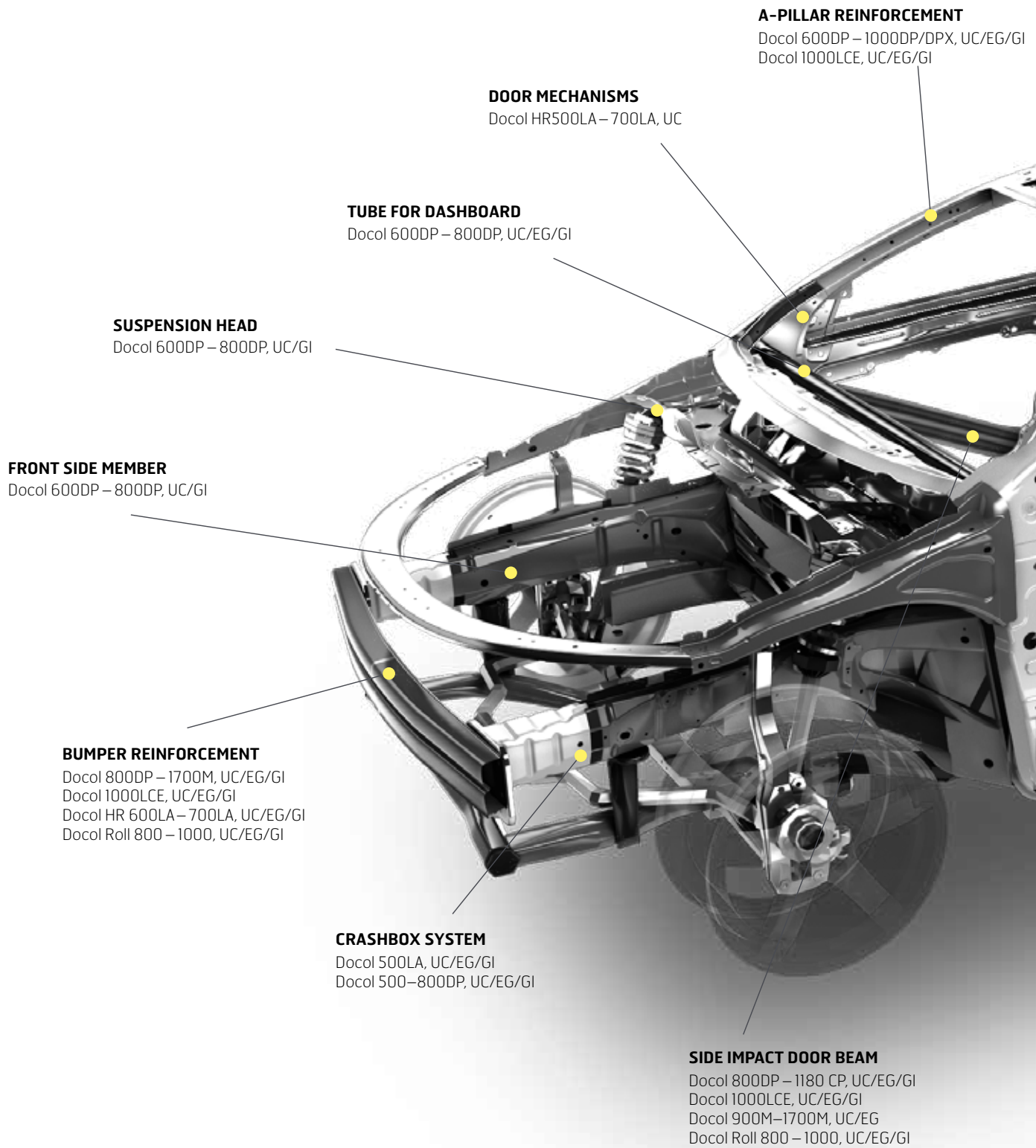

Figure 13. Relation between tool wear and die clearance when blanking in Docol 1400M, with sheet thickness 1 mm.

Typical Uddeholm grades used for manufacturing these car parts are Caldie, Sleipner, Vanadis 8 SuperClean, Vanadis 4 Extra SuperClean and Vancron SuperClean. Other grades can be used depending on factors like design, sheet steel type and thickness.



**ROOF RAIL**

Docol 600DP–1000DP/DPX, UC/EG/GI  
Docol 1000LCE, UC/EG/GI

**ROOF BOW**

Docol 600DP–1180CP, UC/EG/GI  
Docol 1000LCE, UC/EG/GI  
Docol 900M–1700M, UC/EG

**C-PILLAR REINFORCEMENT**

Docol 600DP–1000DP/DPX, UC/EG/GI  
Docol 1000LCE, UC/EG/GI

**B-PILLAR REINFORCEMENT**

Docol 600DP–1180CP, UC/EG/GI  
Docol 1000LCE, UC/EG/GI

**CROSS MEMBER**

Docol 600DP–1180CP, UC/EG/GI  
Docol 1000LCE, UC/EG/GI  
Docol 900M–1700M, UC/EG

**SEAT CROSS BEAM**

Docol 1500M–Docol 1700M, UC/EG

**SILL REINFORCEMENT**

Docol 800DP–1180CP, UC/EG/GI  
Docol 1000LCE, UC/EG/GI  
Docol 900M–1700M, UC/EG

**SEAT FRAME**

Docol 800 DP–Docol 1500 M, UC

**SEAT TRACK**

Docol 800 DP–Docol 1180 CP, UC

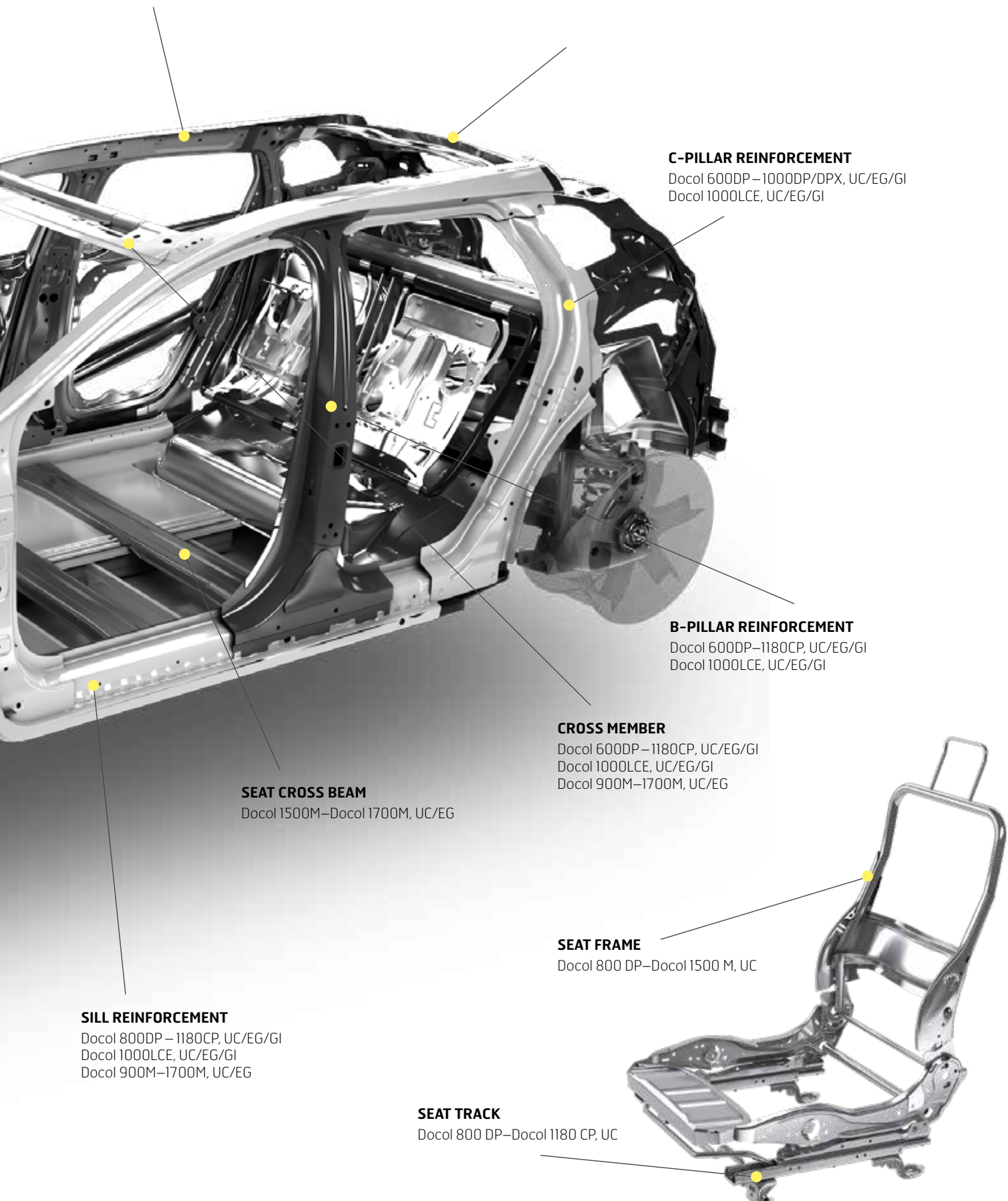

**Blanking and punching force**

The blanking/punching force required is proportional to the sheet steel strength, the sheet thickness and the length of the blanked/punched line. In **Figure 14** the varying punching force is shown when punching a  $\varnothing 5$  mm hole in 1 mm thick sheet, with a 10% die clearance in advanced high strength steel. The blanking/punching force can be quite high when blanking/punching the hardest advanced high strength steel grades. However, the reduction of sheet thickness will normally compensate for the increased blanking/punching forces.

When blanking/punching in the fully martensitic Docol M grades, the force is higher and the work material ductility is low. This means that a spring back or recoil force may be generated. This is noticed as a fast negative force amplitude as shown in **Figure 14**. The spring back generates stress on the tool, which may lead to fatigue cracking after some time. This is shown in **Figure 15**. To avoid production disturbances, the effects of the high blanking/punching forces on the fittings and sharp radii should be considered, as well as the surface finish of the tool.

When blanking/punching in advanced high strength steel with lower strength, the work material ductility is higher which reduces the effects of fatigue and cracking in the tool. For this reason, focus should be on the forces generated when blanking/punching advanced high strength steel with the highest strength, and also how the forces can be reduced. Experiments have shown that the die clearance has a marginal effect on the blanking/punching force. However, the blanking/punching force is somewhat reduced with increased die clearance. Typically a 3 to 5% reduction of blanking/punching force is possible to reach with an increased die clearance.

**Reducing blanking/punching force**

It is important to use the correct blanking/punching parameters. How to select the die clearance when blanking/punching is explained in **section Blanking and punching**. To avoid simultaneous blanking/punching when blanking/punching several holes in one operation, the punches can be of different length. This reduces the required blanking/punching force which otherwise can be considerable. To coat the punching tool is not an effective way to reduce the blanking/punching force. On the contrary, the blanking/punching force can increase as shown in **Figure 18**. A coated punch produces a higher blanking/punching force due to a lower friction between the end surface of the punch and the sheet surface. The lower friction makes the cracking initiation more difficult in the sheet, which increases the blanking/punching force. The increasing force facilitates fatigue cracking in the tool. When cracking starts the coating rapidly comes lose. The most effective way to reduce the blanking/punching force is to chamfer the tool.

Preferably this is made symmetrically to avoid inclined loads on the tool. Chamfering can also be a way to reduce noise. Different ways to chamfer the tool is shown in **Figure 16** and **Figure 17**. How the blanking/punching force can be reduced using symmetrically chamfered punches is shown in **Figure 18**.

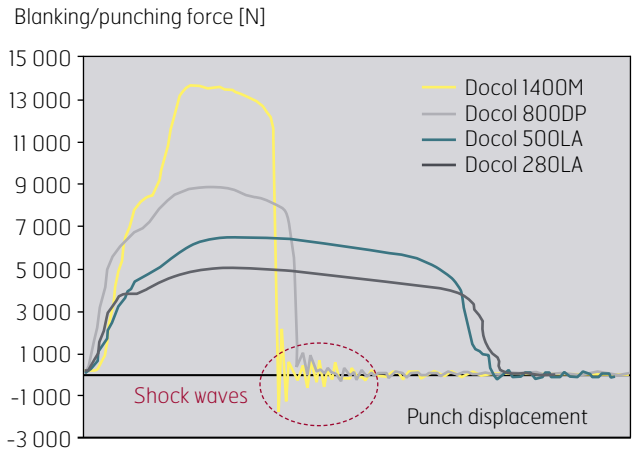

**Figure 14.** Blanking force when punching advanced high strength steel grades.

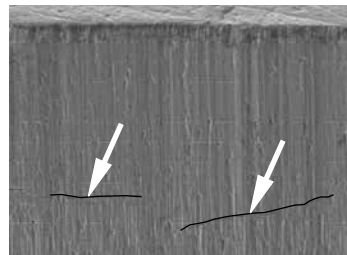

**Figure 15.** Cracking developed as a result of fatigue.

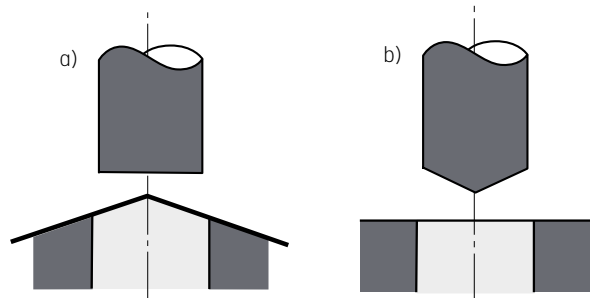

**Figure 16.** Chamfered tools for a) blanking and b) punching.

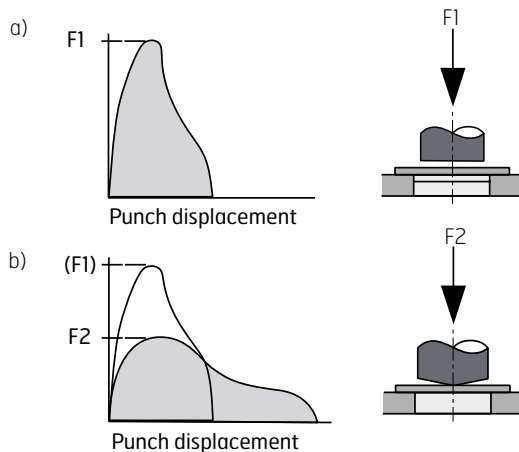

**Figure 17.** Blanking/punching force as a function of punch displacement for a) flat punch or b) chamfered punch.

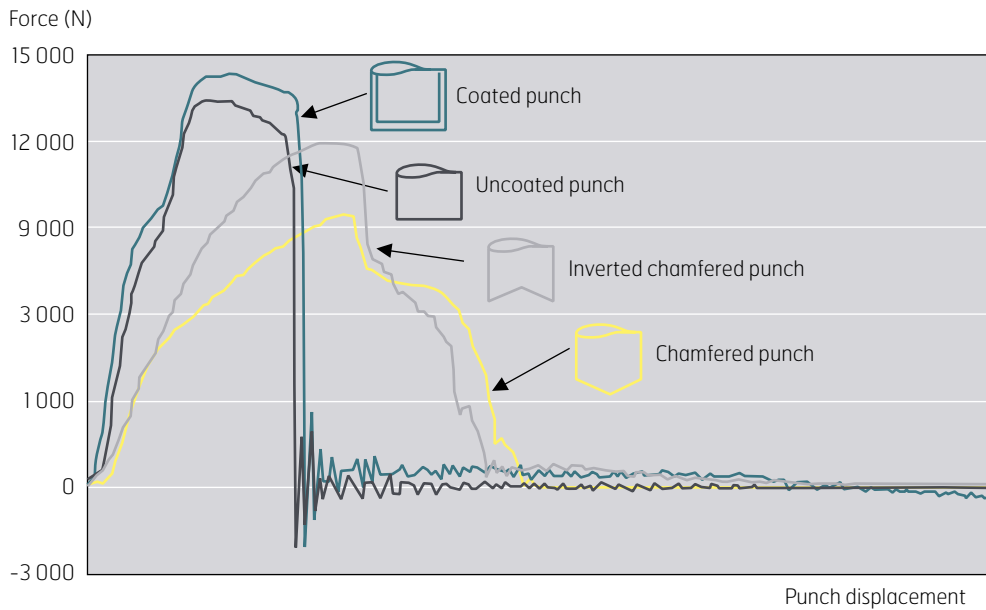

Figure 18. Blanking/punching force when punching a Ø5 mm hole in 1 mm thick Docol 1400M with 10% die clearance.



	-4%	-13%	-25%	-30%
	-8%	-13%	-15%	-10%
	Docol 280LA	Docol 500LA	Docol 800DP	Docol 1400M

Figure 19. Reduction in % of the blanking/punching force for different types of chamfering of the punch (height of chamfer 0.7 times the sheet thickness).



Figure 20. A chamfered punch with a flat centre section.

The blanking/punching force can be reduced by 30% for Docol 1400M with a chamfer of 0.7 times the sheet thickness. The size of the effect of a chamfered punch depends on the work material as shown in **Figure 19**. To obtain a larger reduction effect when blanking/punching mild steel the chamfering must increase to approx. 1.0–1.5 times the sheet thickness. The chamfer should not be unnecessarily large when blanking/punching in advanced high strength steels, just large enough to start the cut before the whole punch end surface area is in contact with the sheet surface. Using an unnecessarily large chamfer will increase the risk of plastic deformation of the punch tip.

Another way to reduce the risk of plastic deformation is to use a chamfered punch with a flat centre section as shown in **Figure 20**.

**NOTE!** Using a chamfered punch does not necessarily mean that the tool wear will be less. The main advantages are force and noise reductions.

**Cutting and shearing**

*Cutting clearance and shearing angle*

In shearing the cutting clearance is the horizontal distance between the upper and lower shear, and the shearing angle is the angle between the upper and lower shear, see **Figure 21**. The shearing angle is normally applied on the upper shear.

In general, similar cutting clearance can be used as for softer sheet steel. The cutting clearance can be somewhat larger when using knives with a shearing angle compared with parallel knives. Cutting clearances are usually smaller compared with blanking. Recommended cutting clearances for advanced high strength sheet can be seen in **Figure 22**.

The selection of shearing angle can be seen in **Figure 23** for different strength levels and sheet thicknesses.

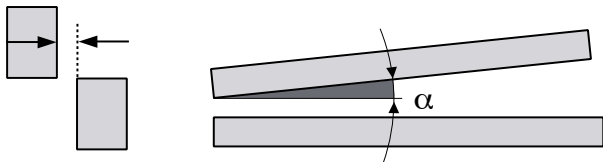

Figure 21. Cutting clearance and shearing angle respectively.

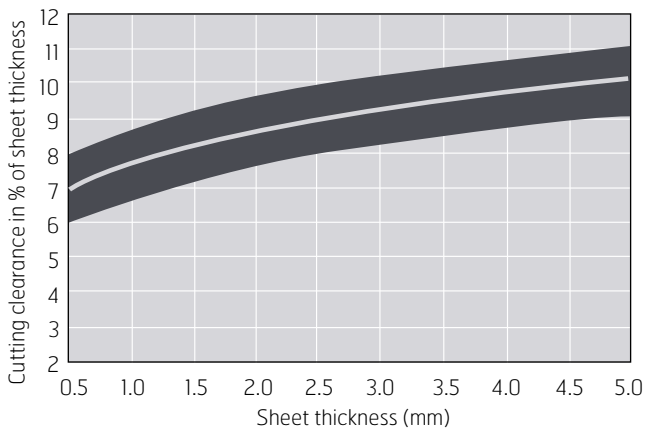

Figure 22. Recommended cutting clearance.

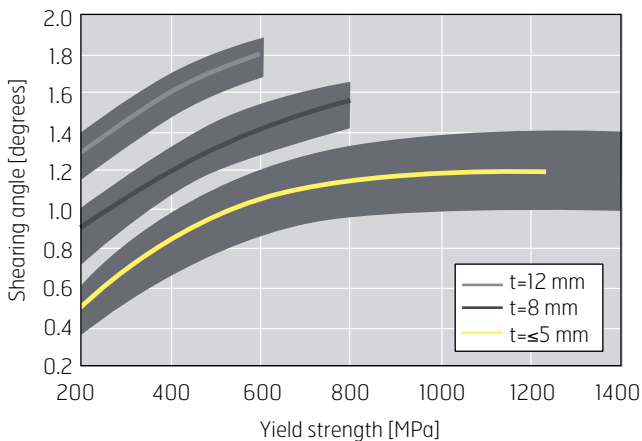

Figure 23. Recommended shearing angles.

*Appearance of a sheet cut edge*

The appearance of the sheet cut edge is similar as when blanking, see **Section General**. Typical sheet edge appearances for three sheet steel grades can be seen in **Figure 24**.

When changing the cutting parameters in shearing the sheet edge appearance changes. A larger cutting clearance with parallel tools gives a larger burnish. On the other hand, a larger cutting clearance when using a shearing angle will give a smaller burnish. When using a high shearing angle in combination with a large cutting clearance, splitting or tearing marks can sometimes be seen in the fracture zone, see upper right photo in **Figure 25**. A large shearing angle when working in Docol M grades can sometimes result in a wavy pattern in the fracture zone, see **Figure 26**.

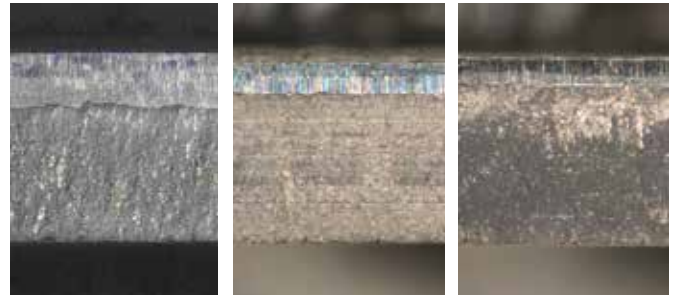

Figure 24. Sheet edge appearance for Docol HR700LA, Docol 800DP-GI and Docol 1400M respectively in thickness 2 mm with 7% cutting clearance and 1° shearing angle.

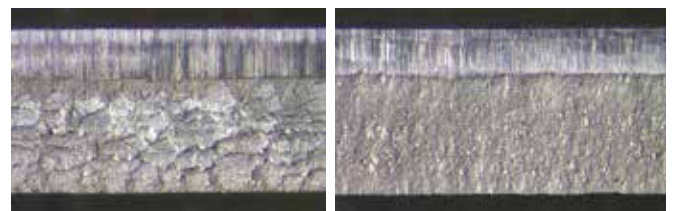

Figure 25. Sheet edge appearance for Docol HR700LA, t=2 mm with different cutting conditions. The left image indicate that cutting clearance and/or shearing angle is too large. The right image indicate that the cutting conditions are OK.

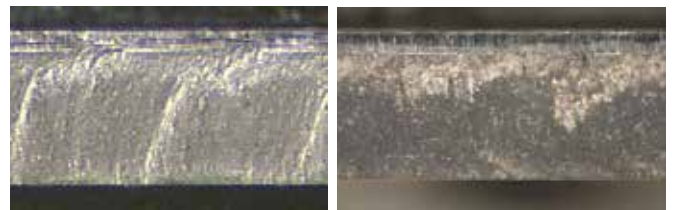

Figure 26. Sheet edge appearance for Docol 1400M, t=2 mm with different cutting conditions. The left image indicate that cutting clearance and/or shearing angle is too large. The right image indicate that the cutting conditions are OK.



### Shearing force

The shearing force required is proportional to the sheet steel strength, the sheet thickness and the length of the cut. The shearing force can be quite high when shearing the hardest advanced high strength steel grades. To avoid high shearing forces a shearing angle should be applied. As soon as a shearing angle is used the difference between advanced high strength sheet steel and mild steel is much smaller, see **Figure 27**. The cutting clearance has very little influence on the total shearing force. The largest force reduction is when going from a parallel shear to 1° shearing angle. There is no benefit to use shearing angles >1.5°. The reduction in total shearing force is low but the tool edge load will be higher and will increase the edge chipping risk.

In power shearing of advanced high strength steels, the first thing asked is often:

– Will I manage a transition from mild sheet steel to advanced high strength sheet steel with the production equipment I have?

An expression for the shearing force is needed to answer that question. For this purpose, SSAB uses the following equation:

$$F = \frac{K_{sk} \cdot t^2}{2 \tan \alpha}$$

where:

F = shearing force

$K_{sk}$  = shearing strength =  $R_m \cdot e$ -factor

$\alpha$  = shearing angle

t = sheet thickness

The shearing strength is calculated as the tensile strength times the e-factor. The e-factor varies with the tensile strength of the material. For mild steels, corresponding to CR1, the e-factor equals 0.8, but for higher strength steels the e-factor decreases to 0.55 with a parallel shear. With a shearing angle it can decrease down to 0.3 for the highest strength sheet material grades. In the diagram in **Figure 28** the e-factor is shown as a function of the work material tensile strength with both parallel shear and with a shearing angle. The e-factor is reduced significantly for advanced high strength steel when using a shearing angle.

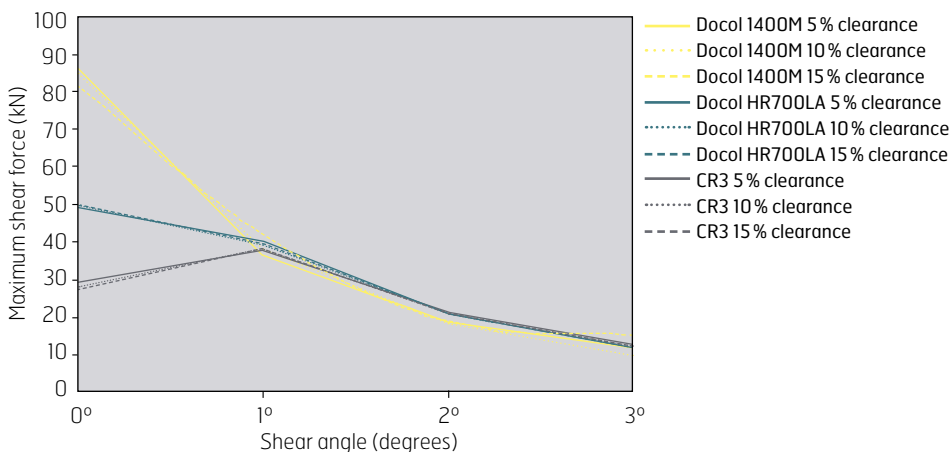

Figure 27. Shear force as a function of shearing angle for different cutting clearances. t=2 mm.

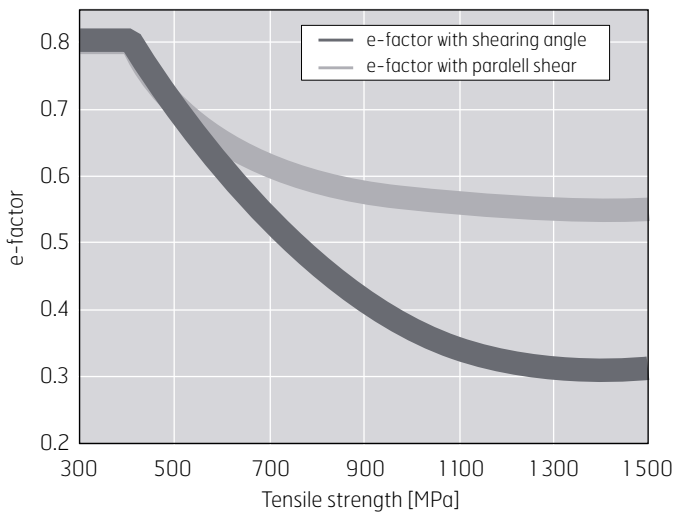

Figure 28. e-factor as a function of the work material tensile strength.

### Tool steel selection and surface treatment in cutting applications

#### Surface treatment

Whether to apply a coating on a tool or not is a question that often arises in tool making. But before a coating is applied, it is important to characterise the wear type. For advanced high strength steel, the type of wear differs depending on the micro-structure and strength level. For dual phase steels, such as Docol 800DP, the adhesive wear is dominating and a coating will certainly reduce the galling properties effectively, as shown in **Figure 29**. Hot dipped galvanized sheets have less tendency to galling due to some lubricating property of the zinc layer.

For hot rolled micro alloyed steels the wear type is mixed with both adhesive and abrasive wear mechanism. If a hot rolled grade is to be blanked in unpickled condition the tool wear rate will be considerably higher and more abrasive. In any case, a coating will significantly reduce the tool wear when blanking in hot rolled grades.

#### Example 1:

Mild sheet steel with a sheet thickness of 8 mm.  
 Work material: SSAB Domex 220YP ( $R_m = 350$  MPa)  
 Shearing force:  $0.8 \times 350 \times 64 / 2 \tan 0.9 = 570$  kN

#### Example 2:

Extra high strength sheet steel with the same sheet thickness = 8 mm  
 Work material: Docol HR700LA ( $R_m = 800$  MPa)  
 Shearing force:  $0.47 \times 800 \times 64 / 2 \tan 1.5 = 459$  kN

#### Example 3:

Extra high strength sheet steel with the sheet thickness reduced by 10% to = 7.2 mm  
 Work material: Docol HR700LA ( $R_m = 800$  MPa)  
 Shearing force:  $0.47 \times 800 \times 51.84 / 2 \tan 1.5 = 372$  kN

The examples show that the shearing force in fact decreases if you transfer from mild to extra high strength sheet steel (using a shearing angle in the same sheet thickness). If you reduce the sheet thickness for the extra high strength sheet steel (with a moderate reduction of only 10% in example 3), the shearing force is reduced by ~35% from the original level.

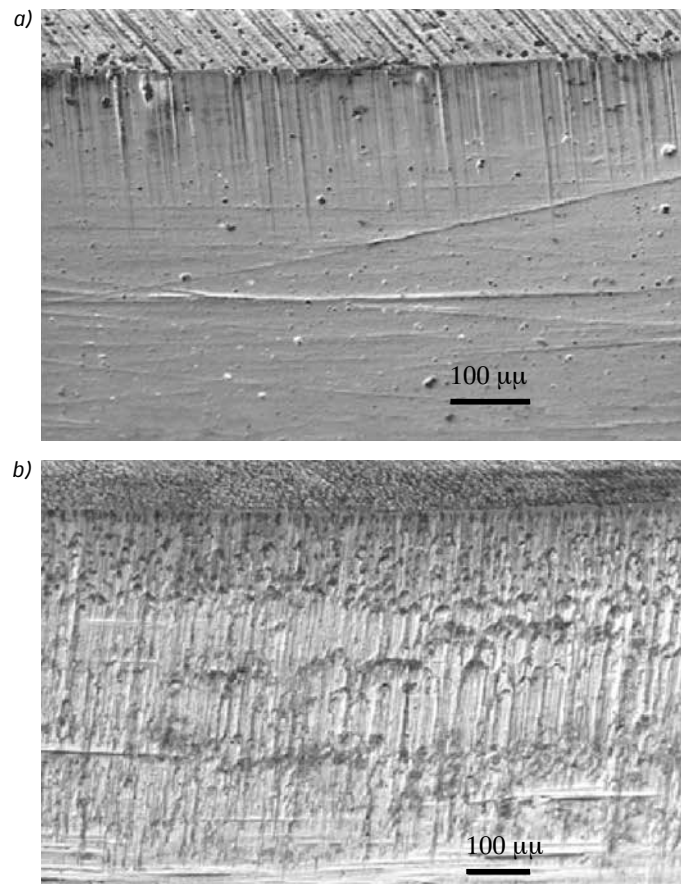
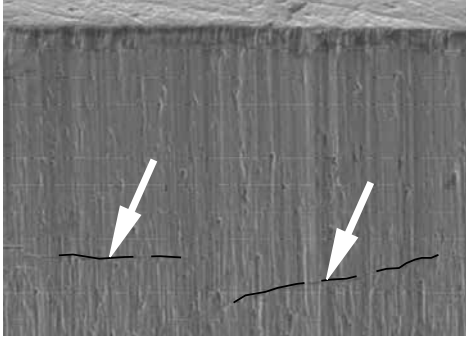

Figure 29. A blanking edge coated with a) PVD-coating (TiAlN) and b) uncoated after 200 000 parts produced in Docol 800DP.

For the fully martensitic steels in Docol M grades, galling will not be the dominating wear mechanism. The wear type is mainly abrasive. Sometimes fatigue cracks can be visible in the worn area, as shown in **Figure 30**.



**Figure 30.** Typical tool wear of an uncoated blanking edge after 100 000 parts produced in Docol 1400M.

As long as fatigue cracks are generated, the coatings will not stay on the tool particularly long. If the preparation before applying a coating is optimised and the most suitable type of coating is applied, the result can be improved so most of the coating is still on after 100,000 parts produced, as shown in **Figure 31**. In any case, nitriding of punch edges should be avoided due to a high risk of cracking the punch edges.

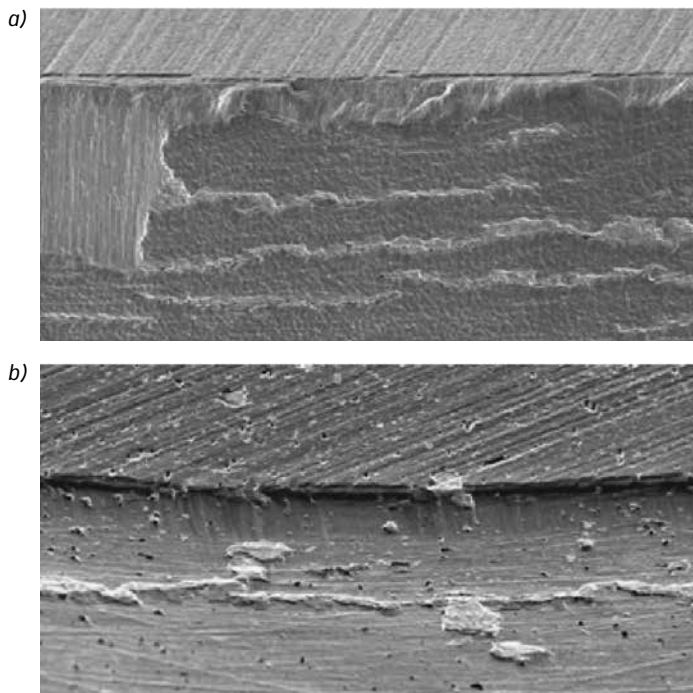

**Figure 31.** Appearance of a tool edge after 100 000 parts produced in Docol 1400M. a) shows a CVD TiCN coating, that has almost completely flaked off. b) shows a multi-layer TiAlN coating with somewhat better performance.

#### *Tool steel selection*

For tool steel selection purposes it is convenient to group the advanced high strength sheet steel materials as follows:

- Docol HR LA grades, uncoated
- Docol DP/DL/LA grades, uncoated
- Docol DP/CP/LA grades, hot-dip galvanized
- Docol M grades, uncoated and electro galvanized.

This is because preliminary blanking/punching tests have revealed that each of the steel groups behave differently during blanking/punching, i.e. each group puts different demands on the tool material. To simplify access to needed information and reduce the risk of misunderstanding, the information relevant for a specific group is presented independently of the information valid for the other groups, although the same information to some extent will be repeated several times.

#### *Docol HR LA grades, uncoated*

These steel grades are hot rolled, micro alloyed steel with relatively high carbon content. They are available in pickled and non-pickled condition, with a thickness range from 2–12 mm (max. 10 mm for Docol HR700LA).

Demands on the tool steel are:

- High wear resistance due to higher carbon content, strength and thickness. High wear resistance is particularly necessary for non-pickled material as the mill scale on its surface is very abrasive.
- High chipping resistance, partly due to relatively high strength, but mainly due to the thickness range.
- Good galling resistance due to relatively high strength and thickness range.

The Docol HR LA uncoated grades are the group that puts the highest demands on the tool material because the thickness range for these grades is by far the widest.

Appropriate grades as a guideline to tool steel selection are:

- Uddeholm Calmax
- Uddeholm Caldie
- Uddeholm Sleipner
- Uddeholm Vanadis 4 Extra SuperClean
- Uddeholm Vanadis 8 SuperClean
- Uddeholm Vancron SuperClean

The property profiles for these tool steels are given in **Table 3**. Below are some general aspects to consider for the recommended

tool steel grades. For the Docol HR LA uncoated sheet steel grades:

- Uddeholm Calmax and Uddeholm Caldie should be used when severe chipping is expected.
- When wear is the main concern Uddeholm Sleipner should be used for short to medium production runs with thinner sheet material.
- Uddeholm Vanadis 8 SuperClean can be used for long production runs when high wear resistance is the most important requirement.
- Uddeholm Vanadis 4 Extra SuperClean should be used when a strong combination of wear resistance and chipping resistance is needed, i.e. for long production runs with thicker and geometrically more complex parts.
- Uncoated Uddeholm Vancron SuperClean should be used for long production runs to counteract galling when blanking/punching thinner, pickled sheet.
- Overlay coatings such as CVD or PVD can be used to counteract wear and galling. All of the above mentioned tool steel grades can be coated, but Uddeholm Vancron SuperClean is normally used uncoated.
- Uddeholm Calmax can be CVD coated but only PVD coated below 250 °C.
- Gas nitriding is not recommended as this can easily cause chipping due to surface embrittlement.
- The hardness level used depends on the sheet thickness and the part geometry. It will normally be in the range 56–64 HRC.

**Docol DP/DL/LA and Roll grades, uncoated**

The Docol DP/DL and Roll sheet steel grades are cold-rolled dual phase steel with low carbon content. These grades are available in thickness from 0.5 to 2.1 mm. The Docol LA grade is a micro alloyed steel and available in thickness from 0.5 to 3.0 mm.

Demands on the tool steel are:

- High wear resistance due to the high sheet strength level.
- High chipping resistance due to the high sheet strength level.
- Good galling resistance due to the high sheet strength level and the presence of ferrite in the sheet.

Appropriate grades and recommended hardness levels for the different sheet strength levels are given in **Table 5**.

Below are some general aspects to consider for the recommended tooling steel grades.

- Overlay coatings such as CVD or PVD can be used for all sheet materials to counteract wear and galling. All of the below mentioned tool steel grades can be coated, but Uddeholm Vancron SuperClean is normally used uncoated.
- Uddeholm Calmax can be CVD coated, but only PVD coated below 250 °C.
- Gas nitriding is not recommended as this can easily cause chipping.
- The hardness level used depends on the sheet thickness and the part geometry. It will normally be in the range 56–64 HRC.

SSAB steel sheet grades	Uddeholm tool steel grades	Tool hardness (HRC)
Docol 500LA–UC Docol 500DP–UC Docol 500DL–UC	Calmax Caldie Sleipner Sverker 21 Vanadis 4 Extra SuperClean Vanadis 8 SuperClean Vancron SuperClean	>56
Docol 600DP–UC Docol 600DL–UC	Calmax Caldie Sleipner Sverker 21 Vanadis 4 Extra SuperClean Vanadis 8 SuperClean Vancron SuperClean	≥58
Docol 800DP–UC Docol 800DL–UC Docol 1000DP–UC/EG Docol Roll 800–UC Docol Roll 1000–UC	Caldie Sleipner Vanadis 4 Extra SuperClean Vanadis 8 SuperClean Vancron SuperClean	≥60

Table 5. Recommended tool steel grades for blanking Docol grades, uncoated.

For the Docol 500LA/DP/DL and Docol 600DP/DL sheet steel grades:

- Uddeholm Calmax and Uddeholm Caldie should be used when severe chipping is expected.
- Uddeholm Sleipner and Uddeholm Sverker 21 should be used for short to medium production runs.
- Uddeholm Vanadis 4 Extra SuperClean should be used when a strong combination of wear resistance and chipping resistance is needed, i.e. for long production runs with thicker and geometrically more complex parts.
- Uddeholm Vanadis 8 SuperClean can be used for long production runs for simple part geometries being blanked/punched from thinner sheet material.
- Uncoated Vancron SuperClean should be used for long production runs to counteract galling.

For the Docol 800DP/DL/Roll and Docol 1000DP/DP-EG/Roll/LCE sheet steel grades:

- Uddeholm Caldie should be used to counteract chipping.
- Uddeholm Sleipner should be used for short to medium production runs.
- Uddeholm Vanadis 4 Extra SuperClean should be used when a strong combination of wear resistance and chipping resistance is needed, i.e. for long production runs with thicker and geometrically more complex parts.

- Uddeholm Vanadis 8 SuperClean can be used for long production runs for simple part geometries being blanked/punched from thinner sheet material.

**Docol DP/CP/LA, hot-dip galvanized**

Docol DP/CP-GI sheet steel grades are cold-rolled dual phase/complex phase steel and are hot-dip galvanized. The Docol LA-GI grade is a hot-dip galvanized micro alloyed steel. These grades are available in thickness from 0.5 to 3 mm.

Demands on the tool steel are:

- High wear resistance is needed for long production runs but the wear is much less than with the non-galvanized grades, as the zinc coating acts as a lubricant.
- High chipping resistance due to high sheet strength level.
- Good galling resistance due to high sheet strength level and presence of ferrite in the sheet.

The soft, sticky zinc coating tends to adhere to the tool surface and should be cleaned off periodically.

Appropriate grades and recommended hardness levels for the different sheet strength levels are given in **Table 6**.

SSAB steel sheet grades	Uddeholm tool steel grades	Tool hardness (HRC)
Docol 460LA-GI Docol 500LA-GI Docol 500DP-GI	Calmax Caldie Sleipner Sverker 21 Vanadis 4 Extra SuperClean Vanadis 8 SuperClean Vancron SuperClean	>56
Docol 600DP-GI Docol 600CP-GI Docol 780CP-GI Docol 980CP-GI	Calmax Caldie Sleipner Sverker 21 Vanadis 4 Extra SuperClean Vanadis 8 SuperClean Vancron SuperClean	≥58
Docol 800DP-GI Docol 800DPX-GI Docol 980DP-GI Docol 1000DPX-GI	Caldie Sleipner Vanadis 4 Extra SuperClean Vanadis 8 SuperClean Vancron SuperClean	≥60

Table 6. Recommended tool steel grades for blanking Docol grades, hot-dip galvanized.

Below are some general aspects to consider for the recommended tooling steel grades.

- Overlay coatings such as CVD or PVD can be used for all sheet materials, to counteract wear and galling. All of the below mentioned tool steel grades can be coated, but Uddeholm Vancron SuperClean is normally used uncoated.
- Uddeholm Calmax can be CVD coated, but only PVD coated below 250 °C.
- Gas nitriding is not recommended as this can easily cause chipping.

For the hot-dip galvanized 460LA, 500LA/DP, 600DP/CP and 780CP sheet steel grades:

- Uddeholm Calmax and Uddeholm Caldie should be used to counteract chipping.
- Uddeholm Sleipner and Uddeholm Sverker 21 should be used for short to medium production runs.
- Uddeholm Vanadis 4 Extra SuperClean should be used when a strong combination of wear resistance and chipping resistance is needed, i.e. for long production runs with thicker and geometrically more complex parts.
- Uddeholm Vanadis 8 SuperClean can be used for long production runs for simple part geometries being blanked/punched from thinner sheet material.
- Uncoated Uddeholm Vancron SuperClean should be used for long production runs to counteract galling.

For the hot-dip galvanized 800/1000DPX, 800/980DP and 980CP grades:

- Uddeholm Caldie should be used to counteract chipping.
- Uddeholm Sleipner should be used for short to medium production runs.
- Uddeholm Vanadis 4 Extra SuperClean should be used when a strong combination of wear resistance and chipping resistance

is needed, i.e. for long production runs with thicker and geometrically more complex parts.

- Uddeholm Vanadis 8 SuperClean can be used for long production runs for simple part geometries being blanked/punched from thinner sheet material.
- Uncoated Uddeholm Vancron SuperClean should be used for long production runs to counteract galling.

**Docol M grades, uncoated and electro galvanized**

The Docol M grades are cold-rolled martensitic steel with low carbon contents. The EG grades have an electrodeposited zinc coating. These steel grades are available in thickness from 0.5 to 2.1 mm.

Appropriate tool steel grades and recommended hardness levels for the different sheet strength levels are given in **Table 7**.

Below are some general aspects to consider for the recommended tooling steel grades:

- Uddeholm Caldie should be used to counteract chipping and cracking.
- Uddeholm Sleipner should be used for short to medium production runs with thinner sheet materials.
- Uddeholm Vanadis 4 Extra SuperClean should be used when a strong combination of wear resistance and chipping resistance is needed, i.e. for long production runs.
- Uddeholm Vanadis 8 SuperClean can be used for long production runs when high wear resistance is the most important requirement. Mainly for simple part geometries being blanked/punched from thinner sheet material.
- Coating can be used, but due to the higher risk of plastic deformation duplex coatings are recommended. The plasma nitriding will give a better support for PVD coating.
- Gas nitriding is not recommended as this can easily cause chipping.

SSAB steel sheet grades	Uddeholm tool steel grades	Tool hardness (HRC)
Docol 1200M – UC/EG Docol 1400M – UC/EG Docol 1500M – UC/EG	Caldie Sleipner Vanadis 4 Extra SuperClean Vanadis 8 SuperClean	≥ 60

Table 7. Recommended tool steel grades for blanking Docol M grades.



## Application examples

### B-pillar reinforcement<sup>1</sup>

B-pillar reinforcement tool with two choices of tool steel material. Both choices are proven to run smoothly.

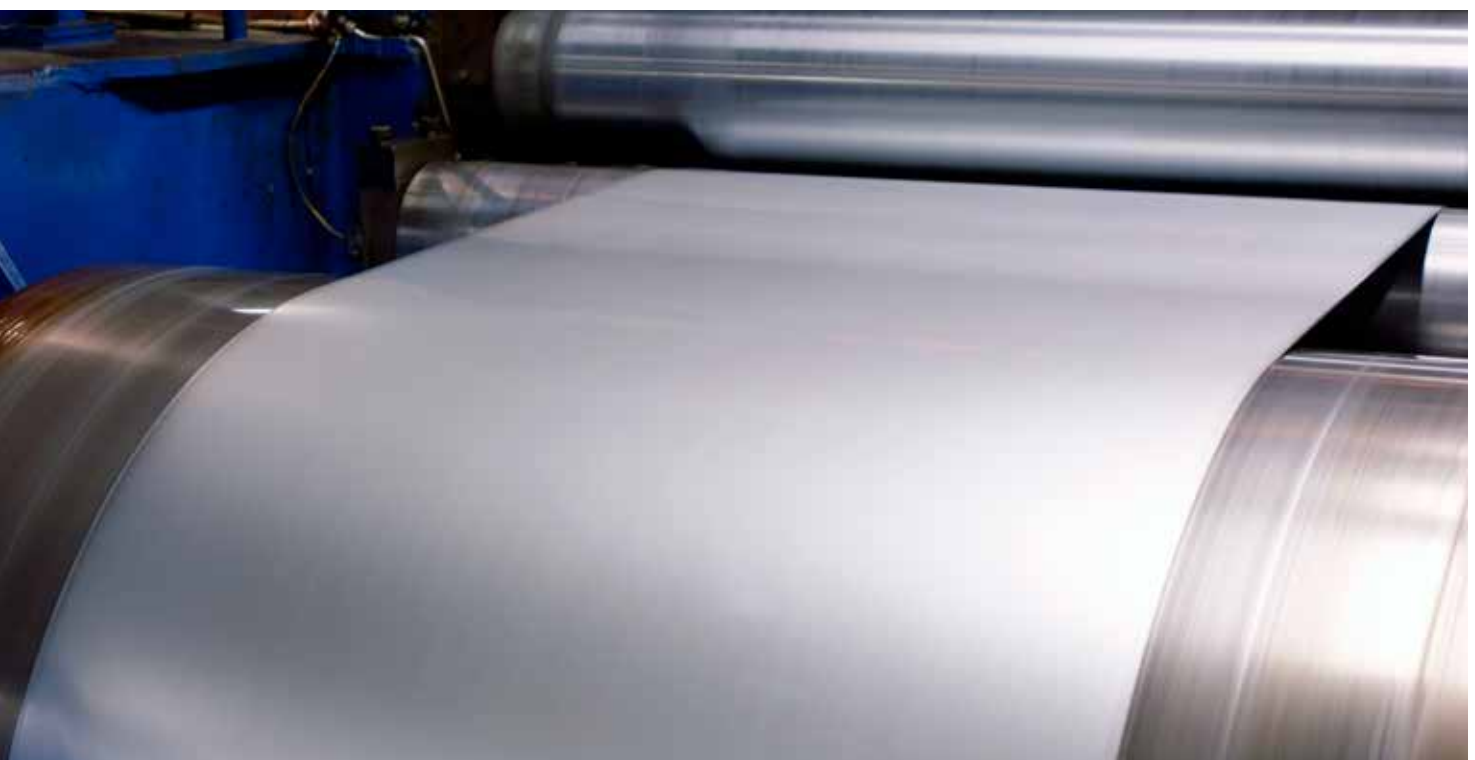

Figure 32. B-pillar reinforcement.

Cold work operations	Blanking and bending
Work material:	Docol 800DP-UC
Work material thickness:	2.0 mm
Number of parts produced per year:	82 000
Tool material in left blanking punch:	Uddeholm Sleipner
Tool material in right blanking punch:	Uddeholm Sverker 21
Tool material in left blanking die:	Uddeholm Sleipner
Tool material in right blanking die:	Uddeholm Sverker 21
Hardness of left and right blanking tool:	HRC 62
Hardness of hole punch:	HRC 60
Tool material in left forming tool:	Uddeholm Vancron SuperClean
Tool material in right forming tool:	Uddeholm Sleipner + CVD, TiC+TiN
Hardness of left forming die:	HRC 62
Hardness of right forming die:	HRC 62
Surface roughness of forming tools:	Ra 0.1 µm
Lubrication	8% oil emulsion

Table 8

<sup>1</sup> Courtesy of Finnveden Metal Structures, Olofstrom, Sweden.





**Bumper for passenger car<sup>2</sup>**

Tooling for bumper to passenger car.

Cold work operations	Blanking and stamping
Work material:	Docol 1000DP–UC
Work material thickness:	2.0 mm
Number of parts produced per year:	300 000
Tool material in blanking tool:	Uddeholm Vanadis 4 Extra SuperClean
Hardness of blanking tool:	HRC 60
Tool material in forming tool:	Uddeholm Vancron SuperClean
Tool material in right forming tool:	Uddeholm Vanadis 4 Extra SuperClean + CVD, TiCN
Hardness of forming tool:	HRC 60
Surface roughness of forming tools:	-
Lubrication	-

Table 9

<sup>2</sup> Courtesy of Essa Palau, Barcelona, Spain.

Figure 33. Bumper for passenger car.



Figure 34. Tow hook bracket.

**Tow hook bracket<sup>3</sup>**

Tooling for tow hook bracket.

Cold work operations	Blanking and bending
Work material:	Docol 1400M–UC
Work material thickness:	2 mm
Number of parts produced per year:	82 000
Tool material in blanking punch:	Uddeholm Sleipner
Tool material in blanking die:	Uddeholm Vanadis 4 Extra SuperClean
Hardness of blanking tools:	HRC 60
Tool material in forming punch:	Uddeholm Sleipner
Tool material in forming die:	Uddeholm Vanadis 4 Extra SuperClean
Hardness of forming punch:	HRC 58
Hardness of forming die:	HRC 60
Surface roughness of forming tools:	-
Lubrication	No additional lubrication

Table 10

<sup>3</sup> Courtesy of Finnveden Metal Structures, Olofstrom, Sweden.

# Lubrication

## Forming tool operations

In forming, the friction between two surfaces in relative motion can be reduced by lubricating the surfaces. The most common lubrication type in stamping sheet steel is mixed lubrication, in which the lubricating film thickness allows for contact between the peaks of the tool and the work material surface. The lubricant is locked up in the irregularities in the surface, and together with the surface peaks, takes up the contact pressure in the forming process. This puts demand on the work material surface roughness (for cold rolled material, EN 10130 – normal surface is valid), and the lubricant's ability to neutralise newly developed reactive surfaces.

The viscosity of the lubricant has a large impact on sheet forming process. Low viscosity lubricants (25–50 cSt) are used for simpler sheet forming operations, but for more demanding stamping operations, a higher viscosity lubricant should be used. See **Figure 35** for the lubricant viscosity influence.



*Figure 35. The influence of lubricant viscosity on drawing. Maximum cup height using lubricant viscosity 500 cSt (left cup) and 40 cSt (right cup).*

## Cutting tool operations

The importance of using additional lubricants depends on several factors when blanking/punching and cutting/shearing advanced high strength steel. Steel grade, sheet thickness and sheet surface have a large influence as well as the tool geometry. In general, lubrication is more important for lower sheet strengths, thicker material and more complex blanking/punching shapes, for example, hole punching with sharp radii in a thick sheet material. Recommended lubricants for blanking/punching in advanced high strength steel are types that resist high contact pressure. The need for additional lubricants differs depending on sheet grades as indicated below.

### **Docol HR LA grades, uncoated**

For hot rolled sheets the use of additional lubricant will benefit the tool life. In particular thicker sheets the lubricant can also reduce the cutting force as well as the retraction force due to lower friction.

### **Docol DP/DL/LA, uncoated**

It is good practice to use lubricants when blanking/punching advanced high strength steel of this type. The ferrite content of these steels introduces a certain amount of sticking on the punch tool, which can be reduced by using additional lubricants.

### **Docol DP/CP/LA grades, hot-dip galvanized**

The need for lubricants is less when blanking/punching hot-dip galvanized sheet materials. The galvanized surface offers a certain lubricating effect. The zinc coating tends to adhere to the tool surface after some production time and should be cleaned off periodically.

### **Docol M grades, uncoated and electro galvanized**

For fully martensitic cold rolled sheet grades such as Docol M, the need for additional lubricants is small. The delivery oil gives adequate lubrication for blanking/punching and cutting/shearing. These sheet grades do not have a tendency to stick onto the tool.

The need for lubricants is less when blanking/punching electro galvanized sheet materials such as Docol M-EG. The galvanized surface offers a certain lubricating effect. The zinc coating tends to adhere to the tool surface after some production time and should be cleaned off periodically.

# Tooling economy

It is very important that a tool produces the required number of parts with a minimum of down time. Production stoppages due to tool breakage or frequent refurbishing cause costly production delays and lower productivity in general. There are several possible issues with the tooling.

The chain from tool design to tool maintenance must remain intact - any weak link can lead to deficiencies. One very important link is the tool material. The tool material has to have the right properties for the application and be of a consistent high quality in order to give reliable tooling.

Advanced tool steel manufacturing processes such as powder metallurgy, ESR and high quality conventional metallurgy mean that extra efforts are made during the production of the tool steel which result in steels that are more expensive than standard grades. However, it should not be forgotten that the tool steel cost is only a small fraction of the total cost of producing a tool - it is only the tip of the iceberg!

If the production costs, including costs for stoppages and maintenance for a certain batch size are considered; the use of a higher quality tool steel will lead to a small increase in the cost of the tooling, but usually give a large return on the investment. This is illustrated in **Figure 37**.

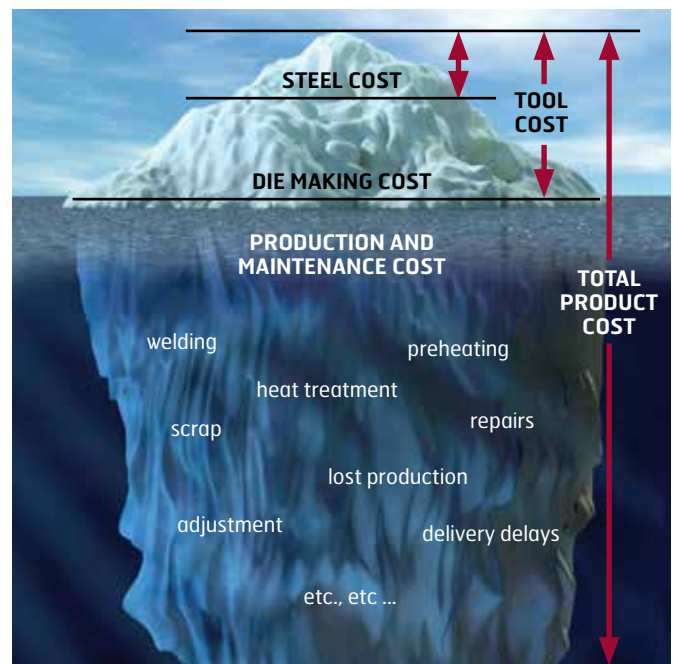

Figure 36. Tool steel cost - only the tip of the iceberg.

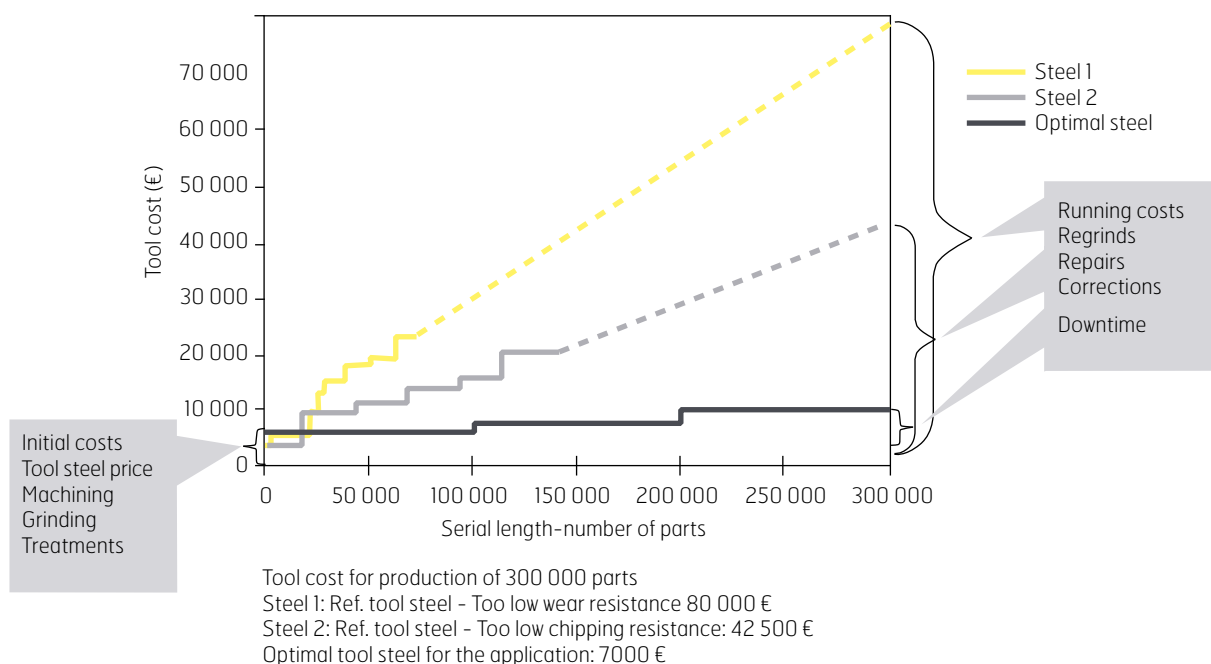
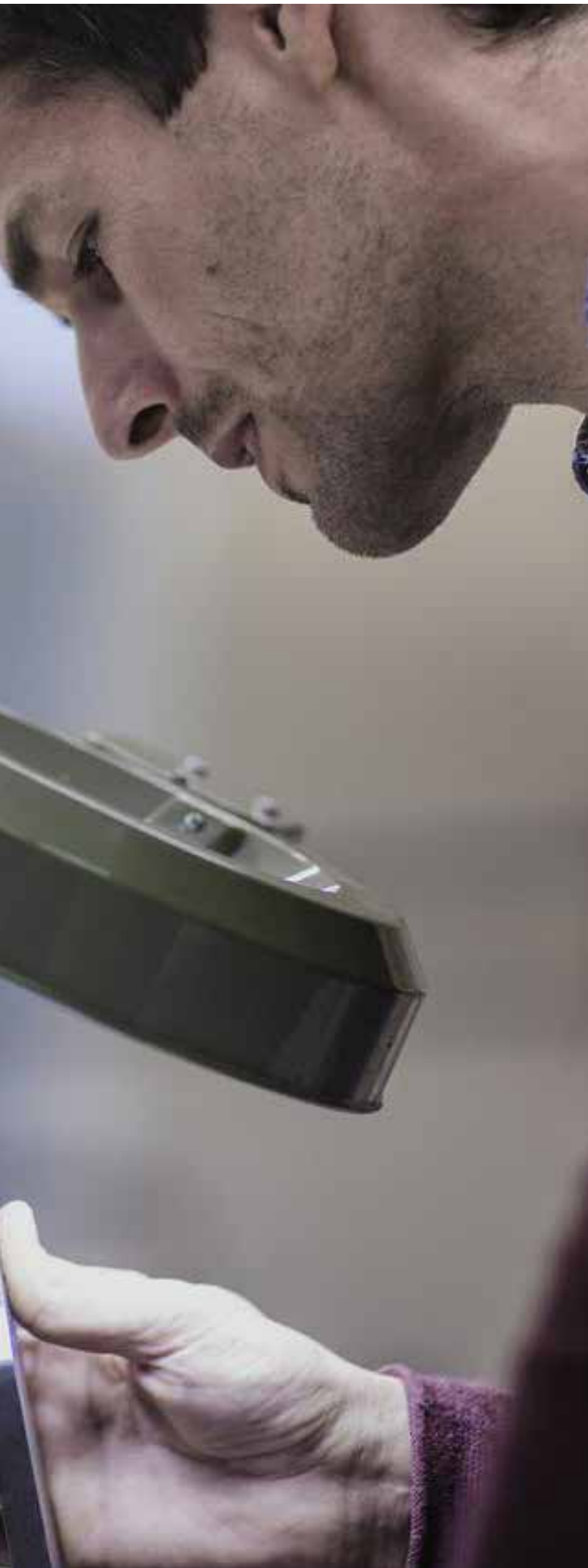

Figure 37. Total tool cost considerations. Steps in lines indicates cost for refurbishment.





## Technical support

### Experts to help you

SSAB can help you put the benefits of advanced high strength steels to full use.

Our experts have many years of experience selecting advanced high strength steel and tool steel in cold work applications.

When changing over to advanced high strength steel, it is important to integrate the material selection, design and production processes right from the beginning. It is then possible to optimize the product and production process from both a technical and economical viewpoint.

The experts at the Knowledge Service Center of SSAB have extensive know-how in material selection and processing as well as leading edge competence in design, forming and joining. The Knowledge Service Center provides personal contact with the application engineers and materials experts of SSAB. Instant support is also available on the internet at [www.ssab.com](http://www.ssab.com) providing full access to a comprehensive database with detailed product facts, downloadable product programs, graphs and other information that simplify design and production.

Our local sales offices can provide advice and solve tooling issues through direct local visits.

### Advanced resources for analysis

Our companies have the very latest equipment to quickly assist customers to choose the right grade of steel sheet, the right design and the right tool steel with the right heat treatment solution.

Our facilities include:

- **The Finite Element Method (FEM)**

This method can be used for simulating all of the stages in the development of a part, such as selection of steel grade, shape of the blank, method of working, and the final geometrical shape of the part. FEM can also be used for calculating the energy absorption capability of a part in a crash. All conceivable variants of tool design, radii, design, thickness and steel grade can be simulated in a computerized environment in order to find the optimum solution.

- **ARAMIS and ASAME Equipment**

This equipment can check quickly that our customers have selected the right combination of steel grade and design. ARAMIS and ASAME measures the strain distribution in press-formed parts. The information is processed in a powerful computer program, and immediate information can be obtained on how the tools, production methods and design have affected the material. ARAMIS and ASAME can perform very detailed analyses of complicated forming operations.

## Courses and seminars

SSAB regularly arrange courses and seminars on how the opportunities offered by advanced high strength steel can be put to use, such as:

- Steel sheet course that offers fundamental knowledge of steel production, and the properties and applications of the various steel grades.
- Seminars providing the delegates with in-depth knowledge of sizing, design, working, forming and joining of advanced high strength steel grades.
- Seminars tailored for individual companies.

## Handbooks

Detailed knowledge of the many opportunities offered by advanced high strength steels and tool steel solutions are included in the SSAB handbooks:

- The Sheet Steel Handbook provides the basis for design and gives advice on design and choice of material and production processes.
- The Sheet Steel Forming Handbook provides increased knowledge of material properties, size shearing, plastic forming and tooling materials.
- The Sheet Steel Joining Handbook provides increased knowledge of all types of welding and joining processes for advanced high strength steels.

## Trial sheets

Whenever you wish to find out how a new grade of steel sheet performs in your production equipment or in the intended product, you can order sheets from our Trial Material Store. Almost every Docol grade of advanced high strength steel produced by SSAB is available with very short notice from our trial material stock.

## Product information

Information on all of SSAB steel sheet grades, how they can be used and worked is available in our product brochures and product leaflets.

SSAB has a large number of sales offices and agents all over the world. Product information and questions can always be handled locally by our local experts.

All product information and guidelines can be found on [www.ssab.com](http://www.ssab.com).



## Sign up for Automotive Insights

Brings you hand-picked  
articles, news and more.  
Sign up at [docol.com](https://www.docol.com)

SSAB is a Nordic and US-based steel company. SSAB offers value added products and services developed in close cooperation with its customers to create a stronger, lighter and more sustainable world. SSAB has employees in over 50 countries. SSAB has production facilities in Sweden, Finland and the US. SSAB is listed on Nasdaq Stockholm and has a secondary listing on Nasdaq Helsinki. [www.ssab.com](https://www.ssab.com)

334en-Docol® – Tooling solutions for advanced high strength steels-v8-2022. Confeitti.

## Contact us:



+46 243 700 00



[automotive@ssab.com](mailto:automotive@ssab.com)



[www.docol.com](https://www.docol.com)



Follow us on LinkedIn

SSAB  
SE-781 84 Borlänge, Sweden

[www.ssab.com](https://www.ssab.com)

**SSAB**